

TENETH



USER MANUAL

V.1.2 MAY 2011

Table of Contents

1. Important Information	3
2. General Information	6
2.1 Introduction	6
2.2 Package Items	6
2.3 View	7
2.3.1 Front view	7
2.3.2 Left and right view	8
2.3.3 Control panel	8
3. Set up your cutting plotter.....	10
3.1 Stand (optional).....	10
3.2 Connect your cutting plotter	10
3.2.1 Connect the AC cable.....	10
3.2.2 Connect the USB cable (optional).....	11
3.2.3 Connect the RS-232 cable (optional)	13
3.3 Blade installation	13
3.4 Blade holder installation.....	14
3.5 loading a sheet.....	15
4. Basic Operations	16
4.1 Pressure Test	16
4.2 Pressure and Speed.....	16
4.3 Languages and Baud rate	16
4.4 X, Y axis scale	17
4.5 Distance between red dot and pen.....	17
4.6 Test the distance between red dot and pen.....	18
4.7 Skin of LCD and Step distance of jog motion	18
4.8 Cutting from FLASH	18
4.9 Cutting from SD card.....	19
4.10 Times of repeat cutting.....	19
4.11 Restore to factory default setting.....	19
4.12 Blade and Laser test.....	19
4.13 Pause and Cancel during operating.....	20
4.14 Origin button	20
5. Advanced operations.....	20
5.1 Cut in FlexiSTATER Teneth Edition	22
5.2 Output from AutoCAD	22
5.2.1 Add a plotter	22
5.2.2 How to output	31

5.3 Cut 5mm or smaller letters.....	34
5.4 Contour Cut (optional).....	36
6. Additional Parts.....	..37

Find More Information and Resources.

Please visit our Website:

If you have any questions, please contact us or email to



Information in this document is subject to change without notice.

Reproduction of these materials in any manner whatsoever without the written permission of Teneth Inc. Is strictly forbidden.

1. Important Information

Before you use the cutting plotter, please make sure that you have read the safety precautions and instructions below.

Notes, Cautions, and Warnings

 NOTE: A NOTE indicates important information that helps you make better use of your cutting plotter.
 CAUTION: A CAUTION indicates either potential damage to cutting plotter or loss of data and tells you how to avoid the problem.
 WARNING: A WARNING indicates a potential for property damage, personal injury, or death.

 WARNING	
Do not disassemble or remodel the plotter.	Handling of the power cable
<ul style="list-style-type: none">• Never disassemble or remodel the plotter. Disassembly or remodeling can result in an electric shock or breakdown of the machine.	<ul style="list-style-type: none">• Use the supplied power cable. Take care not to damage, break or work upon the power cable. If a heavy material is placed on the power cable, or if it is heated or pulled, the power cable can break, thus resulting in fire or electric shocks.
Avoid locating the plotter in a damp environment.	
<ul style="list-style-type: none">• Do not use the plotter in a damp place. Do not splash water onto the machine. Use in such an environment can give rise to fire, electric shocks or breakdown of the plotter.	
In case abnormal event occurs.	

<ul style="list-style-type: none"> • Use of the plotter under an abnormal condition where the device produces smoke or strange smell can result in fire or electric shocks. If such an abnormality is found, be sure to turn off the power switch immediately and unplug the cable from the wall outlet. Check first that the plotter no longer produces smoke, and contact your distributor for repair. • Never repair your plotter by yourself since it is very dangerous for you to do so. 	
---	--

 **CAUTION**

Do not place the cutting plotter in below places:

- A place exposed to direct sunlight.
- On an inclined surface.
- A place where temperature or humidity varies significantly.
Use the plotter under the following environmental conditions:
Operating environment: 20 to 35°C 35 to 65% (Rh)
- A place that vibrates.
- A place exposed to direct air flow from an air conditioner or the like.
- Around a place where flame is Used.

For blade

- Do not touch the cutter blade, which is very sharp.
- Do not shake or swing the cutter holder; otherwise, the blade may come off.

Be careful with the movable parts

- During an operation, do not touch any of the moving parts of this machine (such as the carriage). Also be careful to make sure that clothing and hair do not get caught.

Sheets

- Straighten the sheet of media, if significantly curled, before using it for printing. Heavily curled sheet affects the cutting (plotting) result.

Always put the pinch rollers within the red marks.

Keep the tools away from children where they can reach.

Always connect the power cable to a grounded outlet.

2. General Information

2.1 Introduction

Our cutting plotters have been designed to produce computer-generated images or perform contour cutting on sheets or rolls of vinyl media.





This manual covers the following models of TH/TS cutting plotters:

-TH/TS 740 for media width: 50mm(1.97") ~ 770mm(30.3")

-TH/TS 1300 for media width: 50mm(4.7") ~ 1270mm(50")

2.2 Package Items

The package of the contents the items listed below, please check carefully. If you find any item missing, please consult your local dealer for further assistance.

Item	Parts	Qty	Annotation
1	Warranty card	1	
2	Power cable	1	
3	USB cable	1	
4	Serial cable	1	
5	Blade holder	1	
6	Blade	3	
7	Pen holder	1	
8	CD	1	User manual,USB driver,Artcut driver,AutoCAD sender 2.0, CorelDraw plug-in 3.1,PDF reader,Scale Calculator
Optioal Item			
9	FlexiSTARTER 10	1	
10	Signcut	1	
11	Stand	1	
12	M5*45	16	
13	M5*10	4	
14	M5*8	8	
15	M4*8	8	
16	Washer	16	

2.3 View

2.3.1 Front view

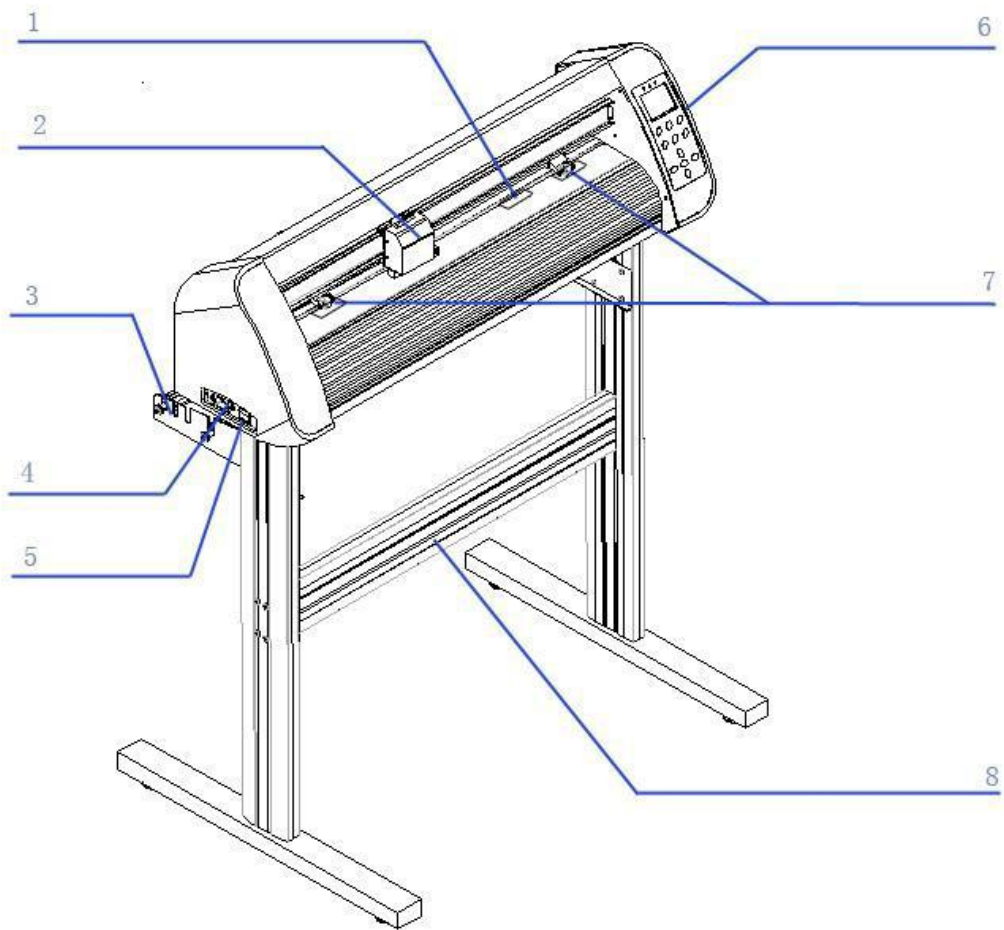

- | | | | |
|---|--------------|---|--------------------|
| 1 | Steel axes | 2 | Carriage |
| 3 | Roll holder | 4 | AC power connector |
| 5 | Power switch | 6 | Control panel |
| 7 | Pinch roller | 8 | Stand (optional) |

More information please see the Floor stand guide video for better understanding.

2.3.2 Left and right view

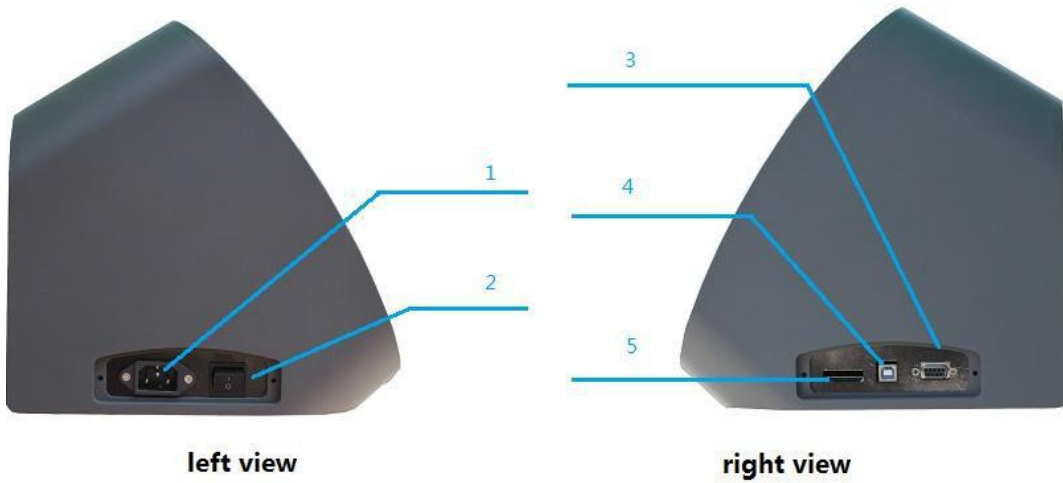

- | | | | |
|---|--------------------|---|--------------|
| 1 | AC power connector | 2 | Power switch |
| 3 | Serial port | 4 | USB port |
| 5 | U disk reader | | |

2.3.3 Control panel

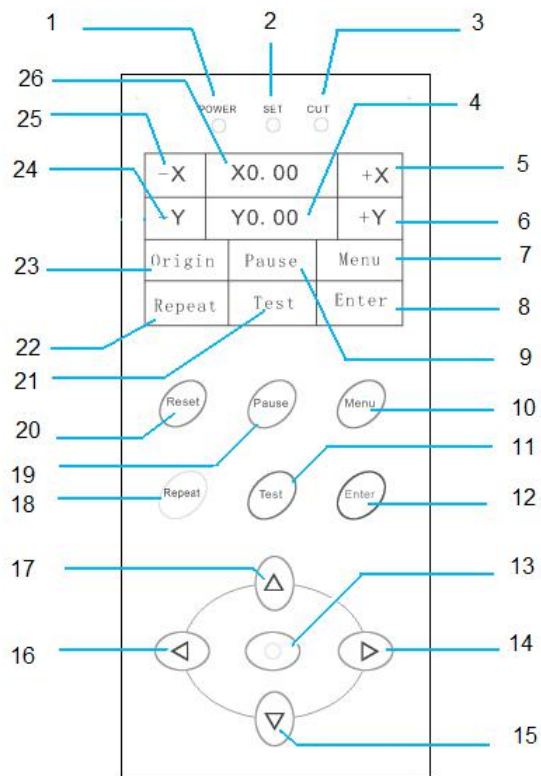

1	power light	2	set up light	3	operate light
4	info status zone	5	X Rightward button	6	Frontward button
7	Menu button	8	Enter button	9	Pause button
10	Menu button	11	Test button	12	Enter button
13	X,Y origin button	14	X Rightward button	15	Y Frontward button
16	X Leftward button	17	Y Backward button	18	Repeat cutting button
19	Pause button	20	Reset button	21	Test button
22	Repeat cutting button	23	X,Y origin button	24	Y Backward button
25	X Leftward button	26	info status zone		

3. Set up your cutting plotter

3.1 Stand (optional)

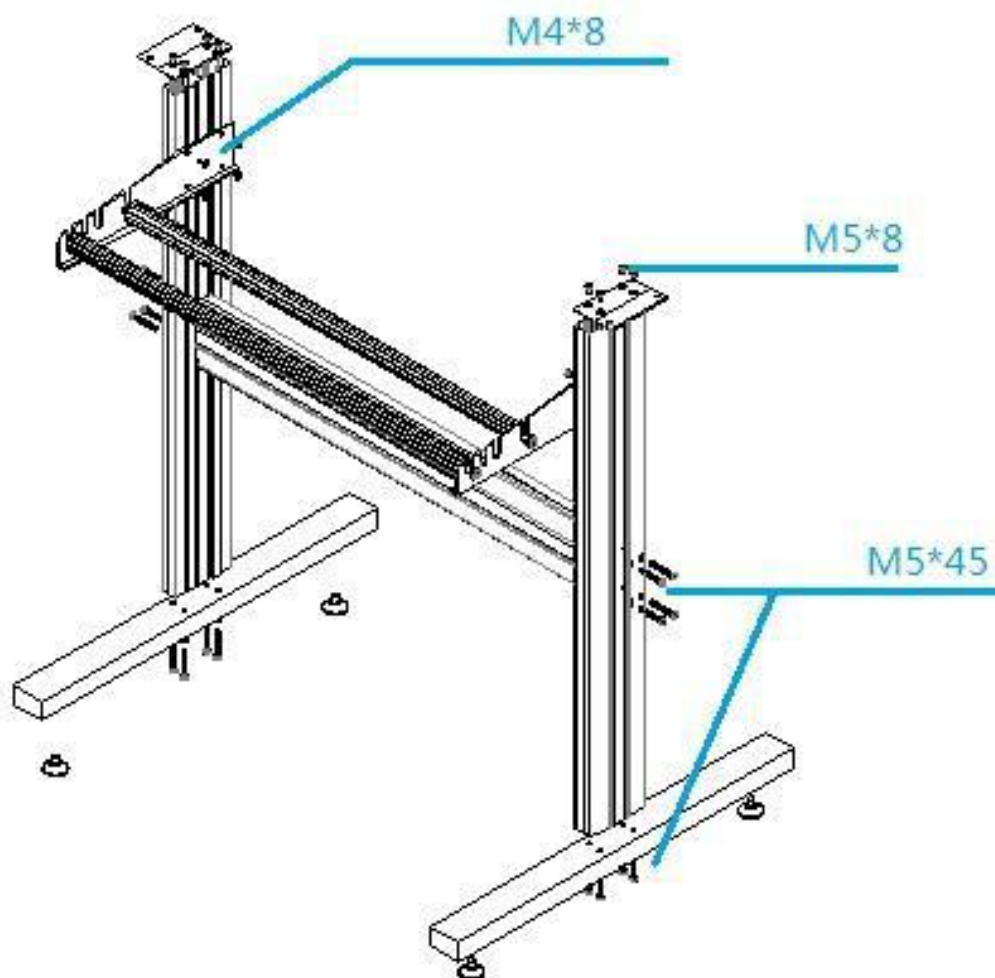

CAUTION: Must use M5*45 screws with washers.

Must use M5*10 screws to fix the cutting plotter to the stand.

3.2 Connect your cutting plotter

3.2.1 Connect the AC cable

→ Insert power supply cable plug into the AC connector ,and then push the power button.

Then the machine is power on.

3.2.2 Connect the USB cable (optional)

If you want to use the USB cable, you have to install the USB driver.

1. Find the following files from the CD, Double-click CDM20814_Setup.exe

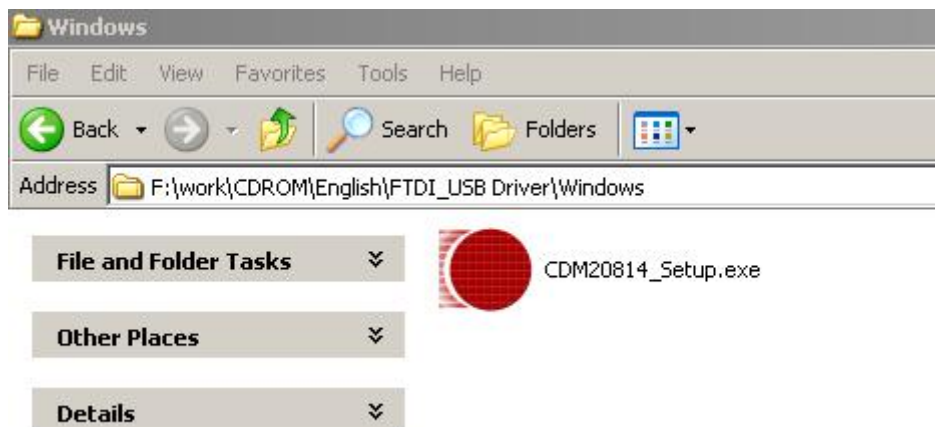

2. connect computer by USB cable, it will display ' Found New Hardware' as follow window.



3. Click "NEXT"



4. Click “Finish”

⑤. If driver was installed successfully, You can find a new port in **Device Manager**, shown as below

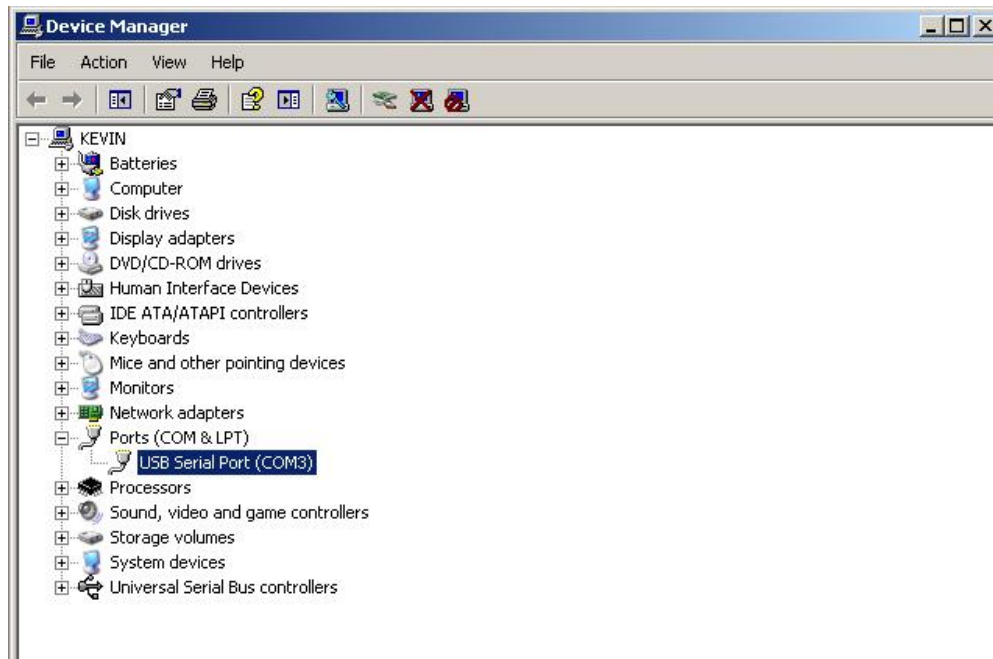

if you want to modify the default port No. of USB driver, just right-click port (COM3) as shown above, and select “**Properties**” in context menu.

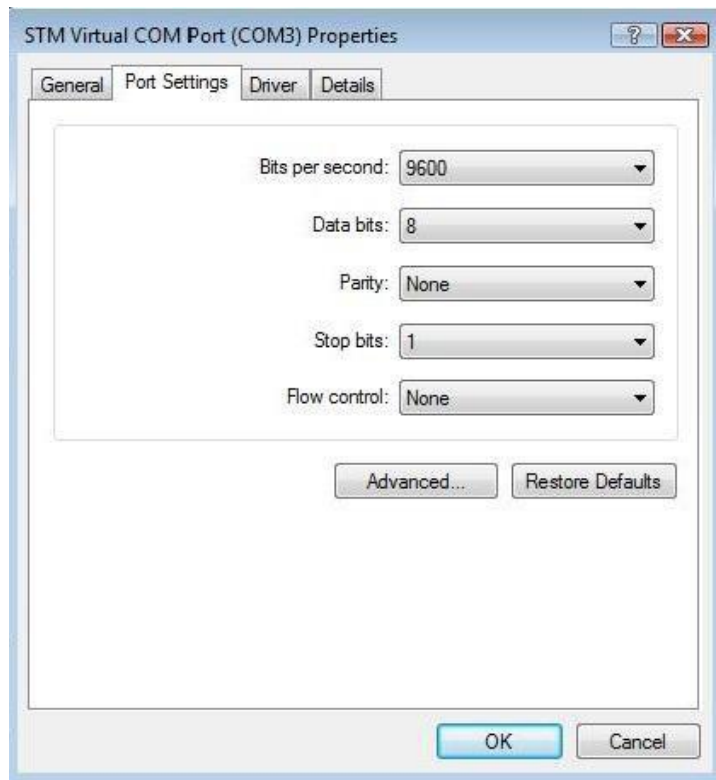

Select “**Advanced...**”,

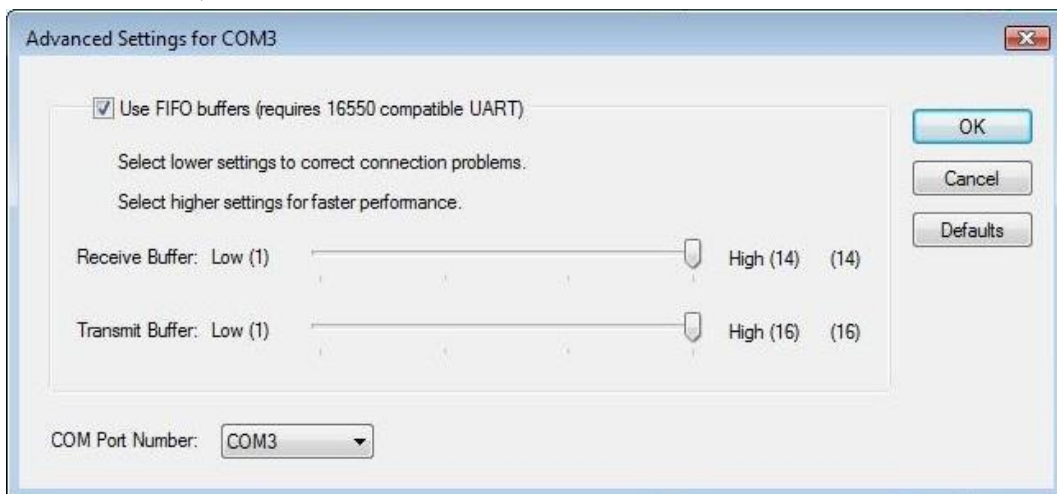

Select the Port Number if you want to modify, then press “**OK**”

3.2.3 Connect the RS-232 cable (optional)

When you want to connect the RS-232C cable, you must observe the following notes



- NOTE:** (1) When connecting the cables, turn off first the power to the device and that to the host computer which the power cable is to be connected.
(2) Do not plug in or unplug any cable during data transferring.

3.3 Blade installation

Figure 3-1 and 3-2 are the drawings of the blade holder.



Figure 3-1



Figure 3-2

How to install a blade

- (1) Remove the blade sheath by rotating it.
- (2) insert the blade into the hole of the blade holder.
- (3) Adjust the blade tip to suitable length by rotating the adjusting knob and blade sheath clockwise or count-clockwise.

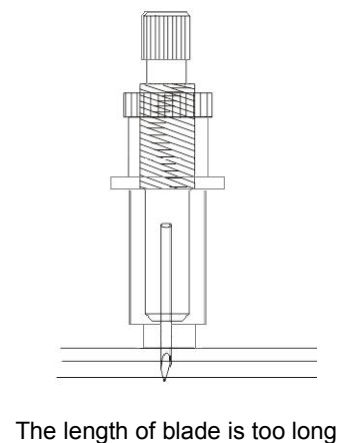
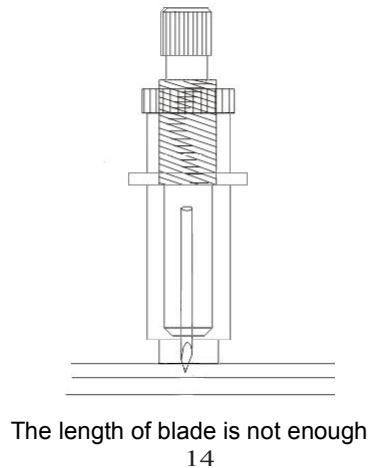
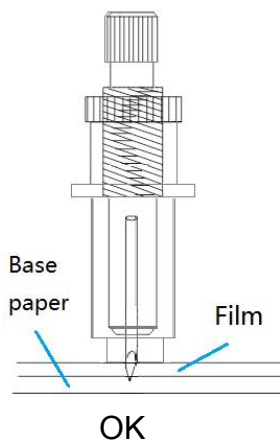



NOTE: The suitable length means the blade's length is adjusted 0.1mm more than film's thickness and it can completely cut through the film layer yet avoid penetrating the base paper.

3.4 Blade holder installation

Install the blade holder into the tool holder of the carriage, press the brim of the blade holder against the tool holder. rotate the knob of the tool holder clockwise and surely fix it.



NOTE: Fix the tool holder firmly. If not, accurate and high-quality cutting will not be achieved.

3.5 loading a sheet

Either a piece of sheet or a roll of sheet can be loaded on the plotter.



Figure 3-3



Figure 3-4

- (1) Lift the lever to rise the pinch rollers. (see Figure 3-3)
- (2) Load the sheet and slide to under the pinch rollers from either the front side or backside. The alignment ruler on the platen will help you to adjust the sheet precisely.
- (3) Slide the pinch rollers manually to the proper position. Be sure the pinch rollers must be positioned above the steel axes. The red mark on the top trail will remind you where the steel axes are.
- (4) Press the lever to lower down the pinch rollers.(see Figure 3-4)
- (5) **Double pressure setting button can set the pinch roller fixed the thickness material well**



NOTE: If you want to cutting a sheet without a reversed adhesive paper (like a pasteboard), You should use a sticker sheet under it.





CAUTION: Move the pinch roller by applying force at the rear portion of the pinch roller support. Do not move it by holding its front rubber roller.

4. Basic Operations

4.1 Pressure Test

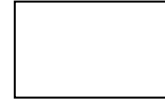
It will help you to know the conditions of the blade.





Press the  or  button, it will cut a rectangle on material, shown as above, Check whether the rectangle can be completely torned off or not in order to make sure the right pressure and the length of the blade tip



NOTE: When the cutter blade is worn and dull, you can use it temporarily by enhancing the value of PRESSURE. However, you are recommended to replace the worn cutter blade with a new one to ensure a satisfactory cutting quality.

4.2 Pressure and Speed









(1) Press  or  button goes to the interface



-X	F100	+X
-Y	V500	+Y

 in



which F100 is the pressure 100g, V500 is the speed 500mm/s.

(2)

Pressure	 or 	Decrease the pressure	Once for 5 Min is 5
	 or 	Increase the pressure	Once for 5 Max is 500*
Speed	 or 	Decrease the speed	Once for 25 Min is 50
	 or 	Increase the speed	Once for 25 Max is 500

(2) After adjusting the Pressure or Speed, press  or  to save the settings.

4.3 Languages and Baud rate









(1) Press  or  button to goes to the interface

-X	F100	+X
-Y	V500	+Y

, and

then press  red button one time to go to the interface

-X	English	+X
-Y	B38400	+Y



Language	 or 	Switching between Chinese and English
	 or 	
Baud rate	 or 	Switching Between 38400 and 56000
	 or 	

Then press  or  to save the settings.



NOTE: To ensure it works, the baud rate of cutter must be the same as the software on computer.

4.4 X, Y axis scale







(1) Press  or  button goes to the interface



-X	F100	+X
-Y	V500	+Y

And then press  goes to the interface

-X	Sx0	+X
-Y	Sy0	+Y

which SX0 is the proportionality factor of X axis; SY0 is the proportionality factor of Y axis. Factor default is 0, if there is an error in the plotter, You can adjust them.

X axis	 or 	Decrease proportion of X axis
	 or 	Increase the proportion of X axis
Y axis	 or 	Decrease the proportion of Y axis
	 or 	Increase the proportion of Y axis

(3) Then press  or  to save the settings.

 **NOTE:** The value of the axis scale depends on the actual situation.

4.5 Distance between red dot and pen



(1) Press  or  button goes to the interface

-X	F100	+X
-Y	V500	+Y





Press  to go to the interface

-X	Dx 0	+X
-Y	Dy 0	+Y

(2) Fix the sheet and pen in machine, and press the pen manually to **make a dot** on the material.

(3) Press  or  button, LCD will display interface and the carriage will give a **red dot** in material.

-X	Dx Set	+X
-Y	Dy Set	+Y



(4) Press 4 arrow Keys , , , , to move the red dot to the center of the dot just made by pen, (total central overlapped)

(5) Then press  or  to save the settings.

 **NOTE:** The settings will be stored in plotter all the time until you clear it.

4.6 Test the distance between red dot and pen

To test the distance from laser to pen is exact or not



(1) Press  or  button one time and then press  goes to the

-X	F100	+X
-Y	V500	+Y





interface, press  several times to go to this interface





-X	Dx 0	+X
-Y	Dy 0	+Y



Fix the sheet and pen and press pen to make a dot on the sheet.

(3) Press  or  button, the red dot will locate the dot automatically, if the red dot don't aim at the dot, It needs to be reset.

4.7 Skin of LCD and Step distance of jog motion









, , ,  are continuous motion keys.

, , ,  are jog motion keys, You can set the distance of motion here, default is 5.0mm.

(1) Press  or  button goes to the interface
And then press  to go to this interface

-X	F100	+X
-Y	V500	+Y

-X	Skin:0	+X
-Y	STEP:5	+Y

Skin	 or 	Change the skin of LCD, there are 6 skins available
	 or 	
Distance of motion	 or 	Decrease the distance of motion, the min is 0.1mm
	 or 	Increase the distance of motion, the max is 100.0mm.

(3) Then press  or  to save the settings.

4.8 Cutting from FLASH

The plotter has a built-in FLASH, Every file sent by computer will be saved in the built-in FLASH automatically. If it powered off, the file will not be lost, you can reuse it for cutting and no need to be sent by computer again.

(1) Press  or  goes to the interface

-X	Flash	+X
-Y	Work ?	-Y

(2) Press  or  will continue processing the last working file.

4.9 Cutting from U disk

The plotter can cut a file from U disk, the format of the file should be **.PLT**.





(1) Copy the **.PLT** format file to U disk, Insert the card into the plotter.



(2) Press  or  two times to go to the screen

-X	SDCard	+X
-Y	Work ?	+Y

(3) Press  or  goes to the screen

-X	I:Name	+X
-Y	O:ABC	-Y

(4) Press , , ,  to find the file you want to cut, it will display the file name

(5) Press  or , the machine starts working.

4.10 Times of repeat cutting

When you cut files from FLASH or U disk, you can set the times for repeat cutting

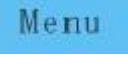
(1) Press  or  button to

-X	F100	+X
-Y	V500	+Y









And then press  several times to go to

-X	Copy:1	+X
-Y		+Y

 goes to the screen .

-X	Copy:1	+X
-Y		+Y

(2)

Numbers of Copy	 or 	Increase the times of repeat cutting
	 or 	
	 or 	Decrease the times of repeat cutting
	 or 	



NOTE: The default is 1 time, Max is 500 times.

4.13 Pause and Cancel during operating

(1) During operating, press  or , the screen will change to

-X	F100	+X
-Y	V500	+Y

, press  or  again, the plotter will continue operating

(2) In Pause status, press  or  will cancel the current job.

4.14 Origin button

5. Advanced operations

5.1 Cut in FlexiSTATER Edition

- (1) Install the software
- (2) After finishing the installation, run the **Production Manager**, Click “**Setup**”->”**Add setup...**”.

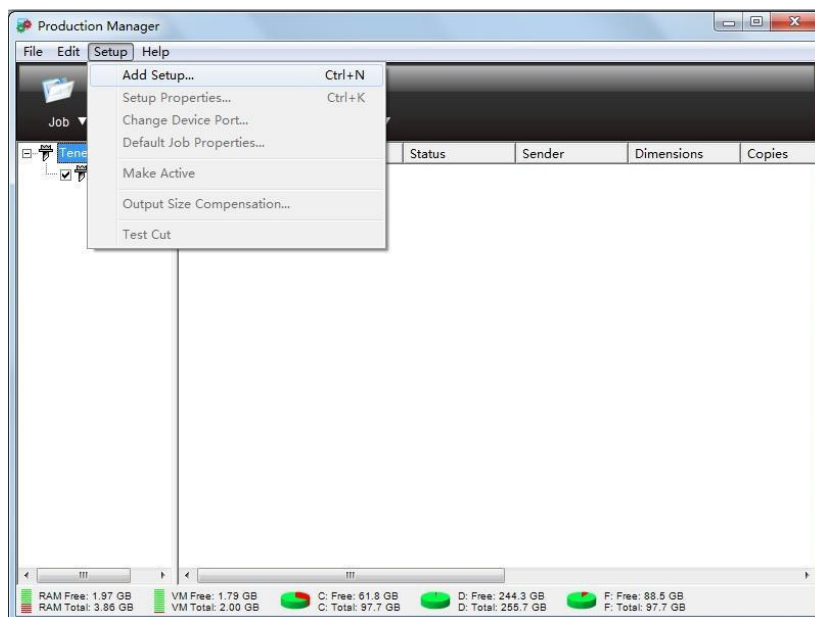

- (3) Select the names of brand and model upon your plotter, and click “**Next**”

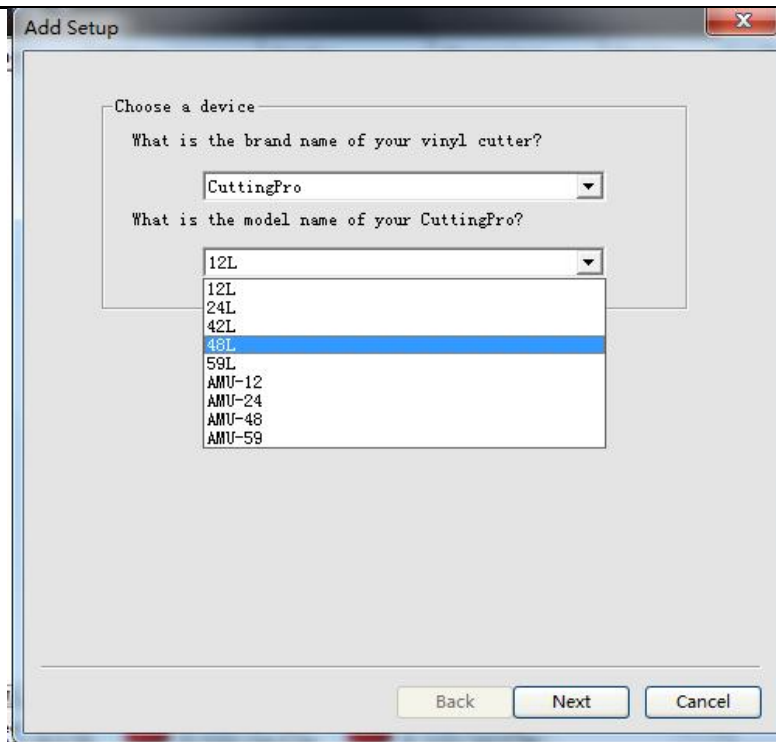

(4) Set parameters as below:

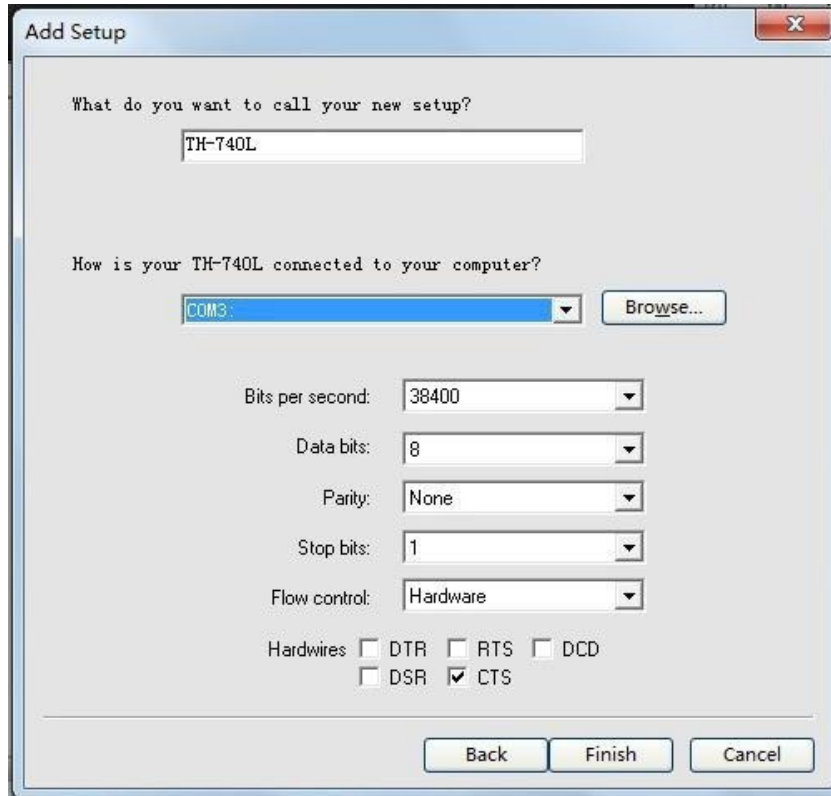

(5) Click "Finish".

5.2 Output from AutoCAD

5.2.1 Add a plotter

(1) Click the main menu-> "Print" -> "Manage Plotters"

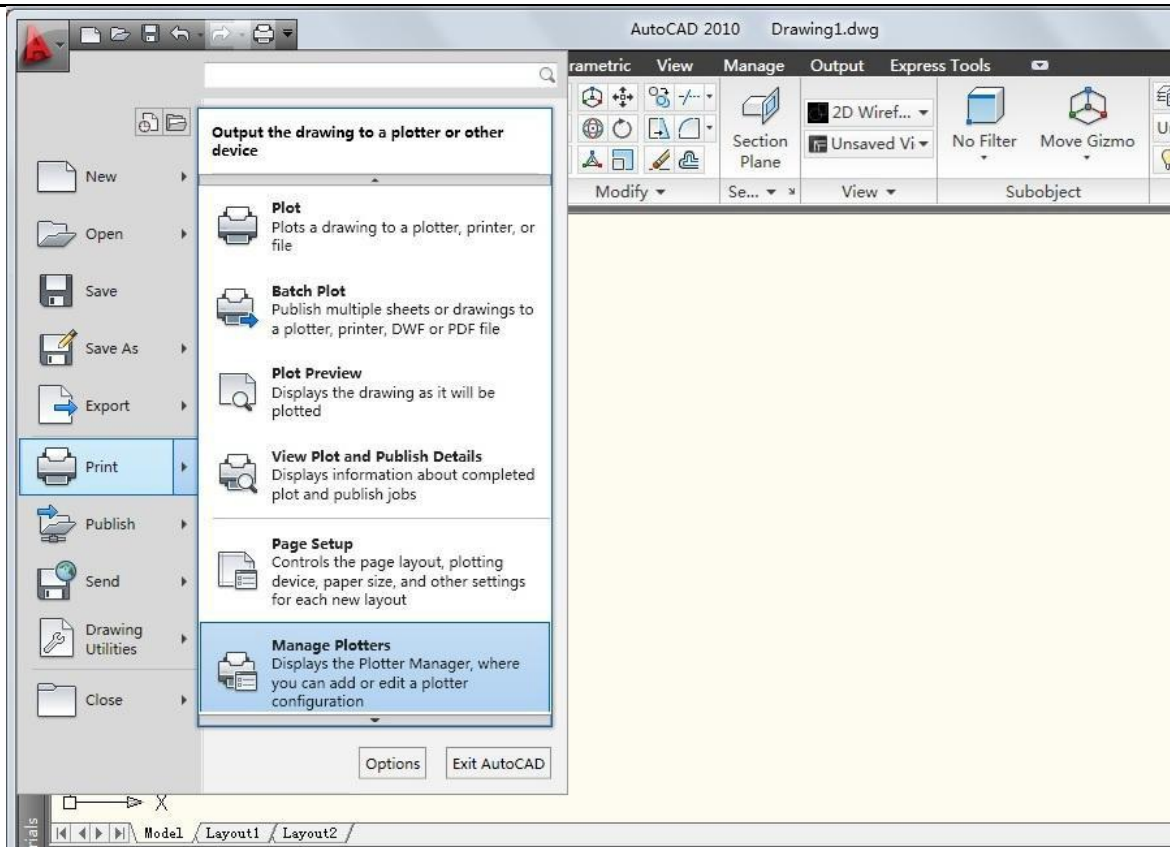

(2) It will display “**Plotters**” window, double click “**Add-a-Plotter Wizard**”.

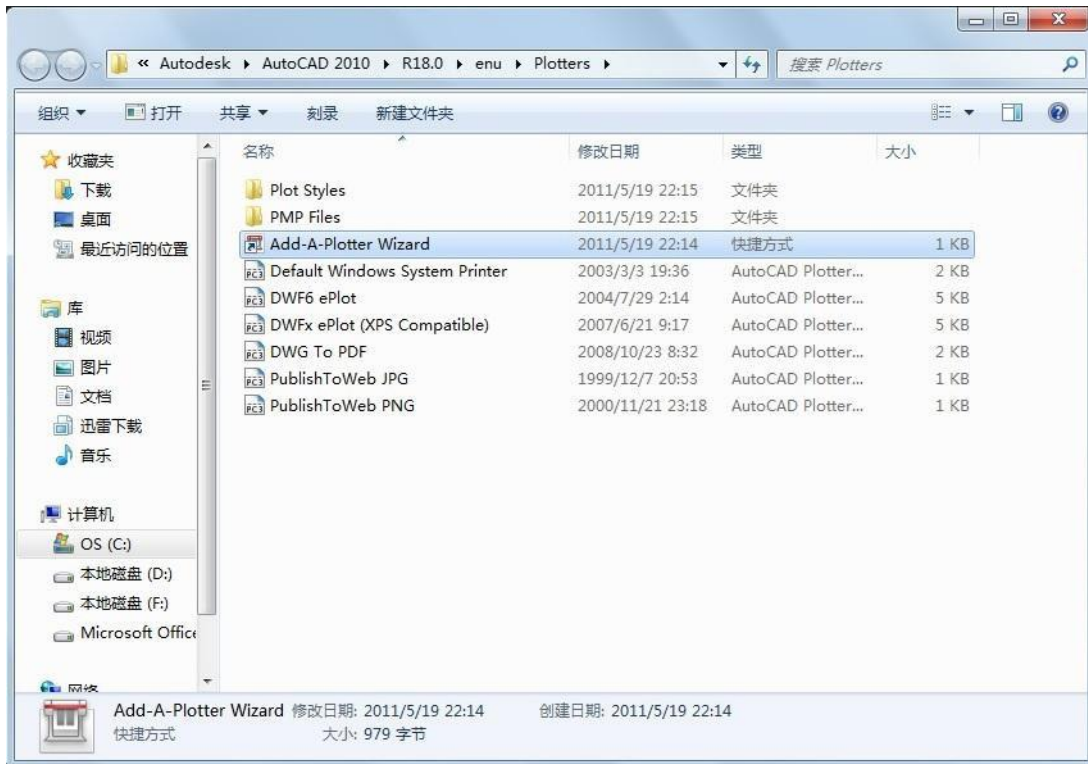

(3) It will display the following dialog box, click “Next”.

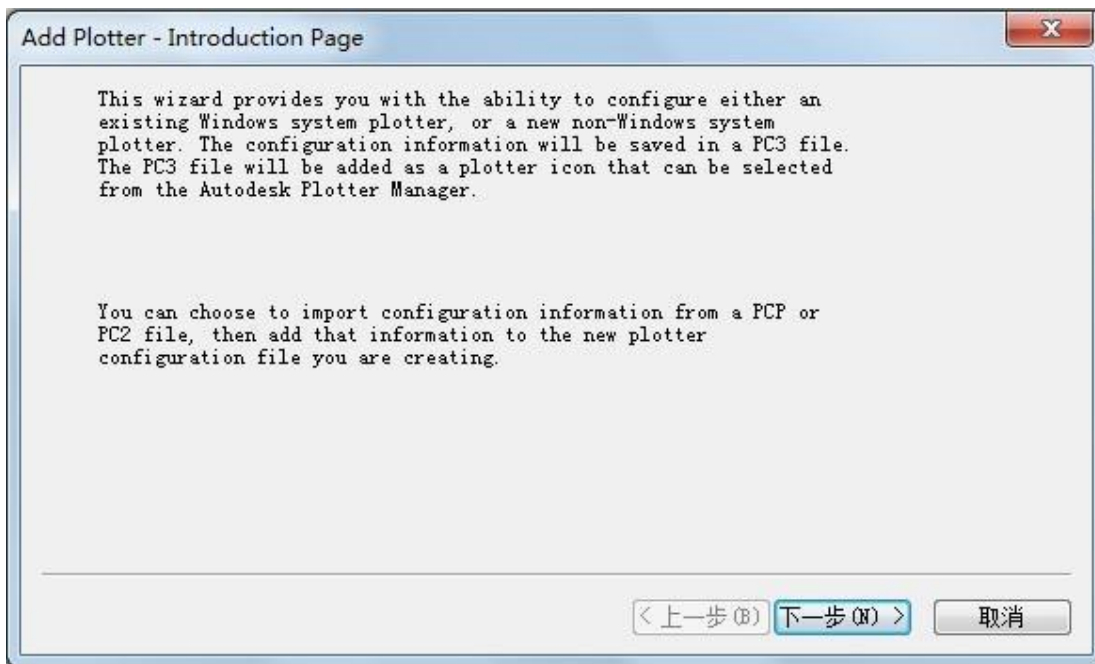

(4) Select “My Computer”, and then click “Next”.

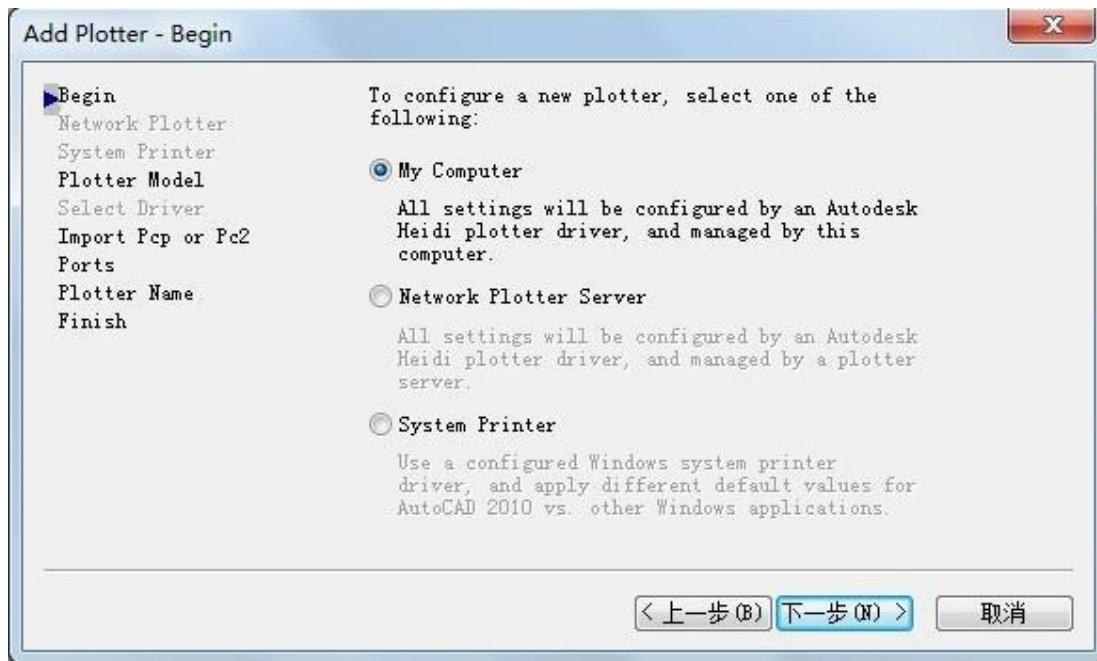

- (5) Select **“Hewlett-Packard”** for Manufacturers and **“Generic SHPGL”** for Models, and then click **“Next”**.

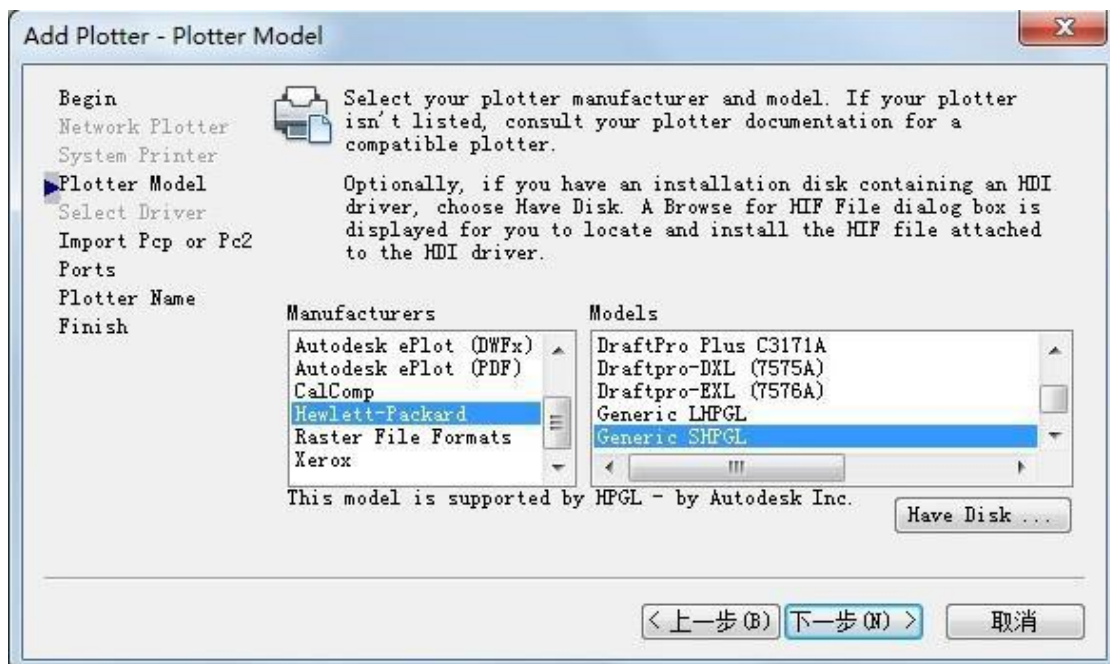

- (6) Click **“Next”** in following dialog box.

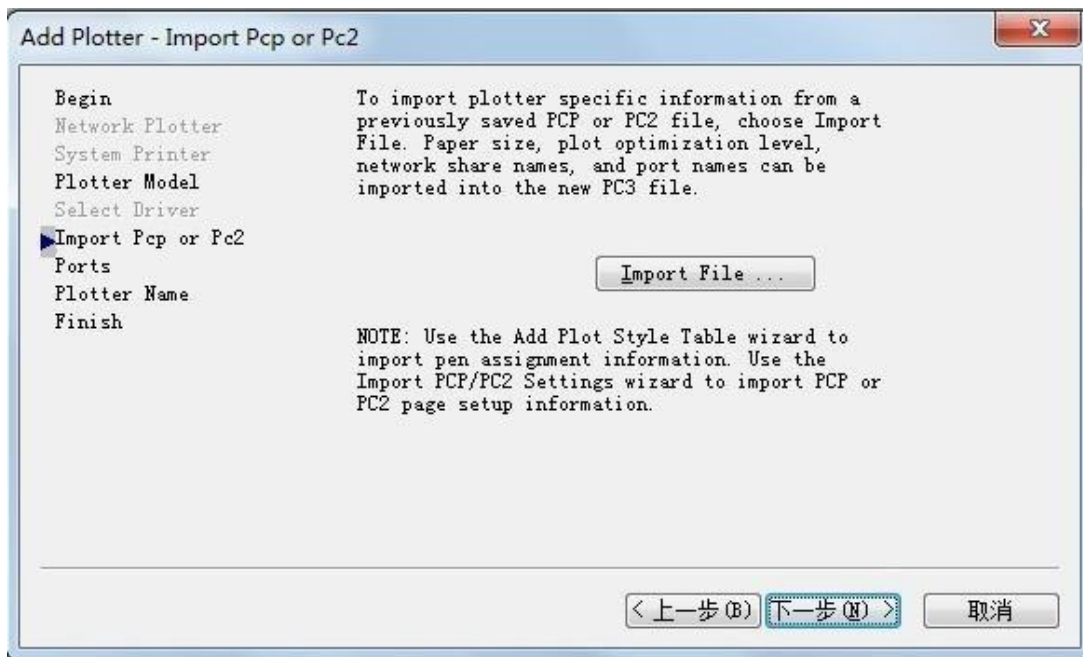

(7) Select “Plot to File”, and then click “Next”.

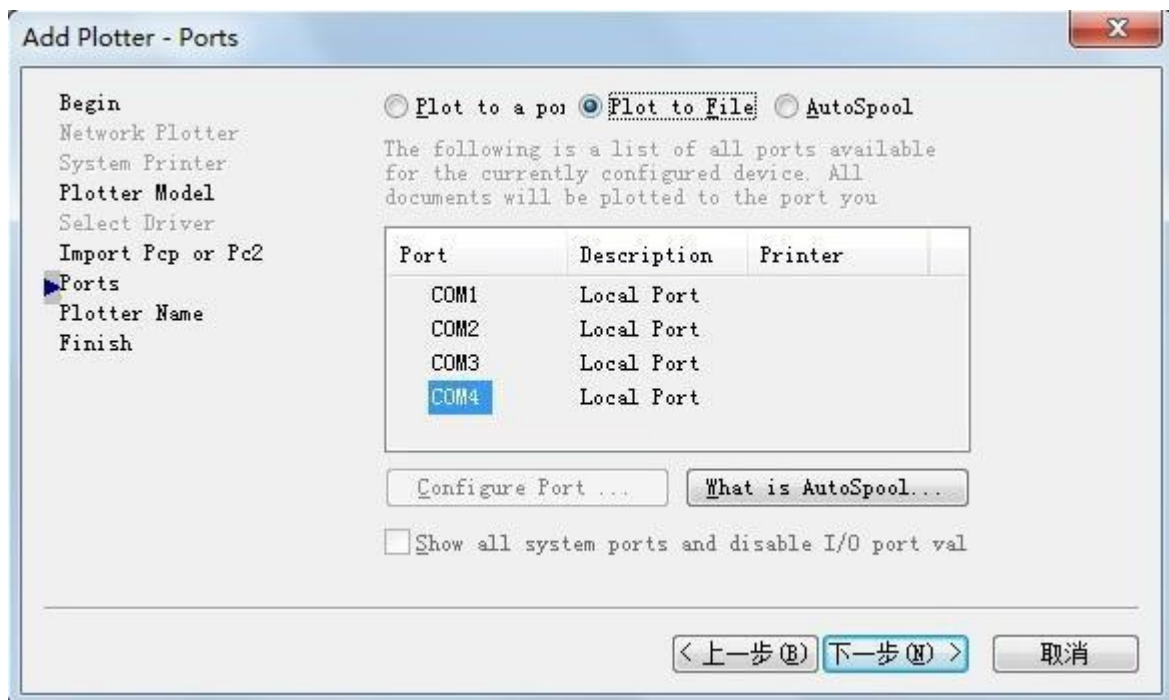

(8) Enter a name for plotter, and then click “Next”.

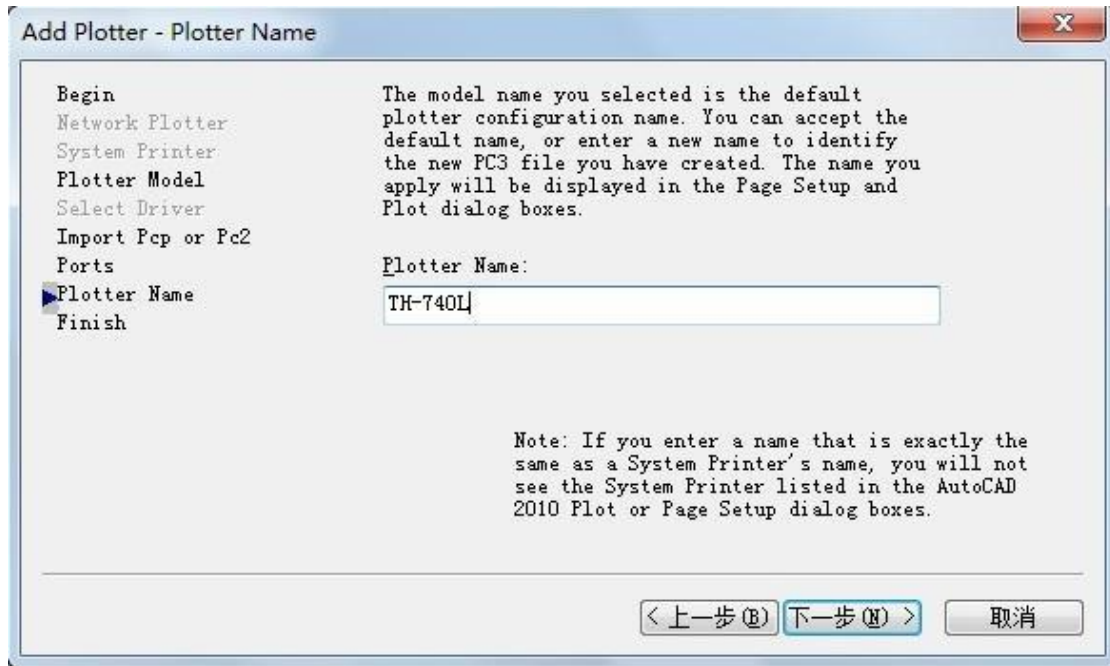

(9) Click **“Edit Plotter Configuration”** to set the parameters.



(10) Select **“Custom Paper Sizes”**, and click **“Add...”**.

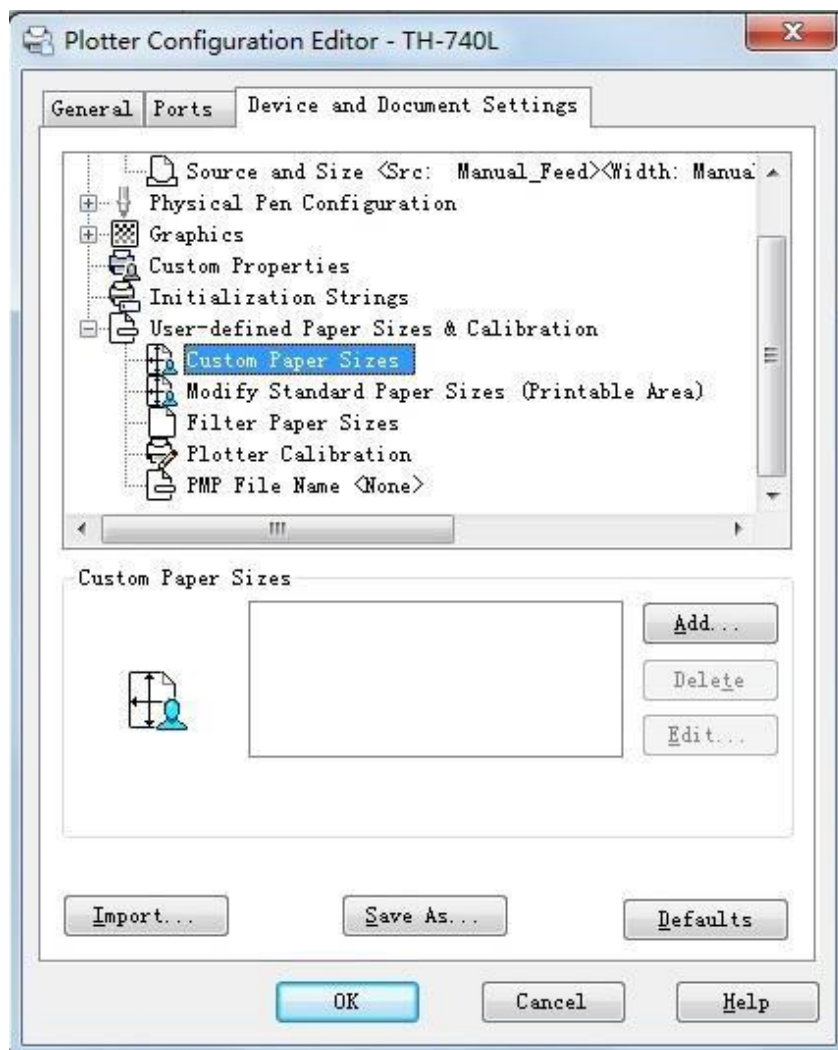

(11) Select **“Start from scratch”**, and then click **“Next”**.

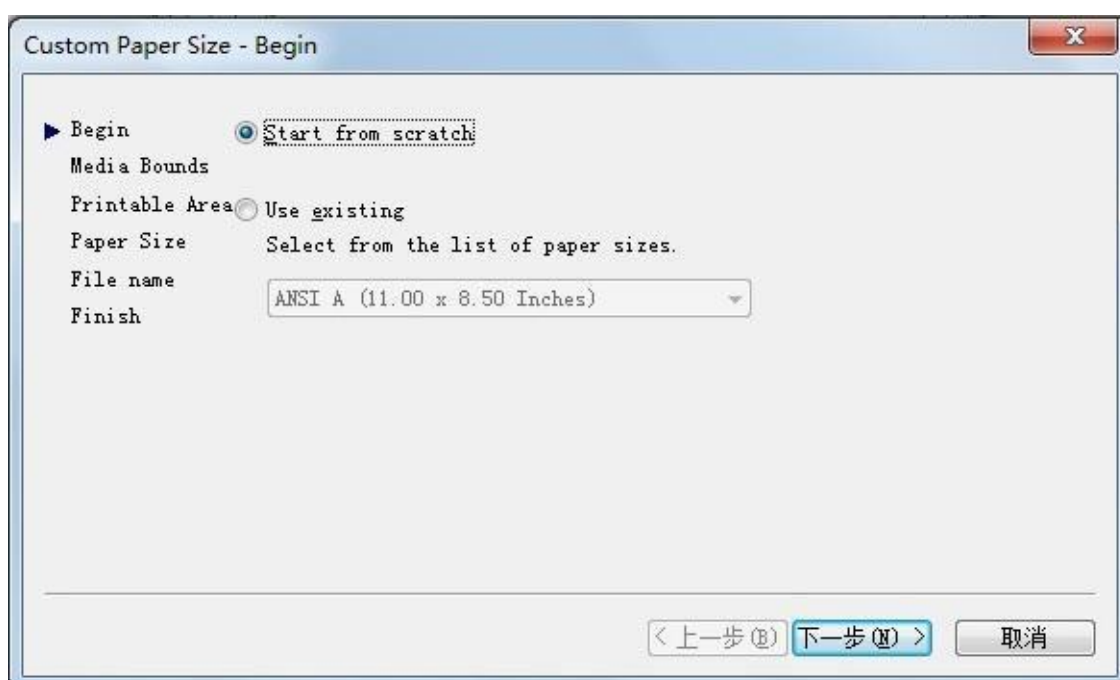

- (12) Enter the appropriate value for Width and Height according to your plotter, and click “Next”.

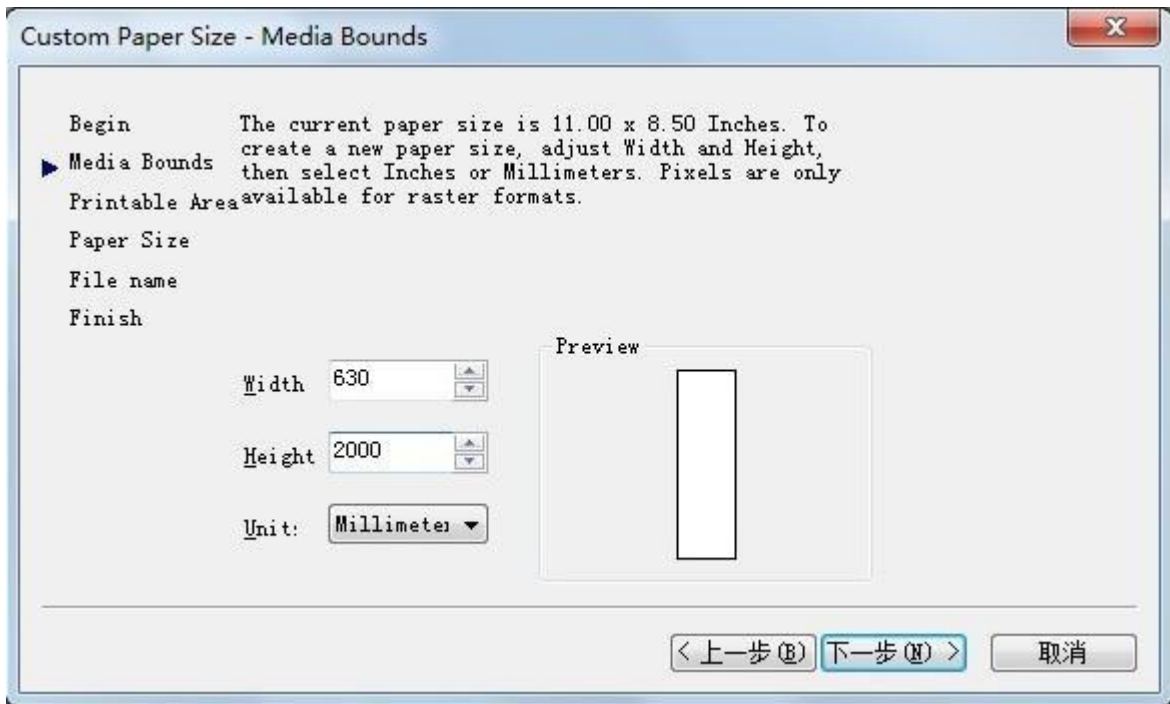

- (13) Enter the value for the non-printable area, and then click “Next”.

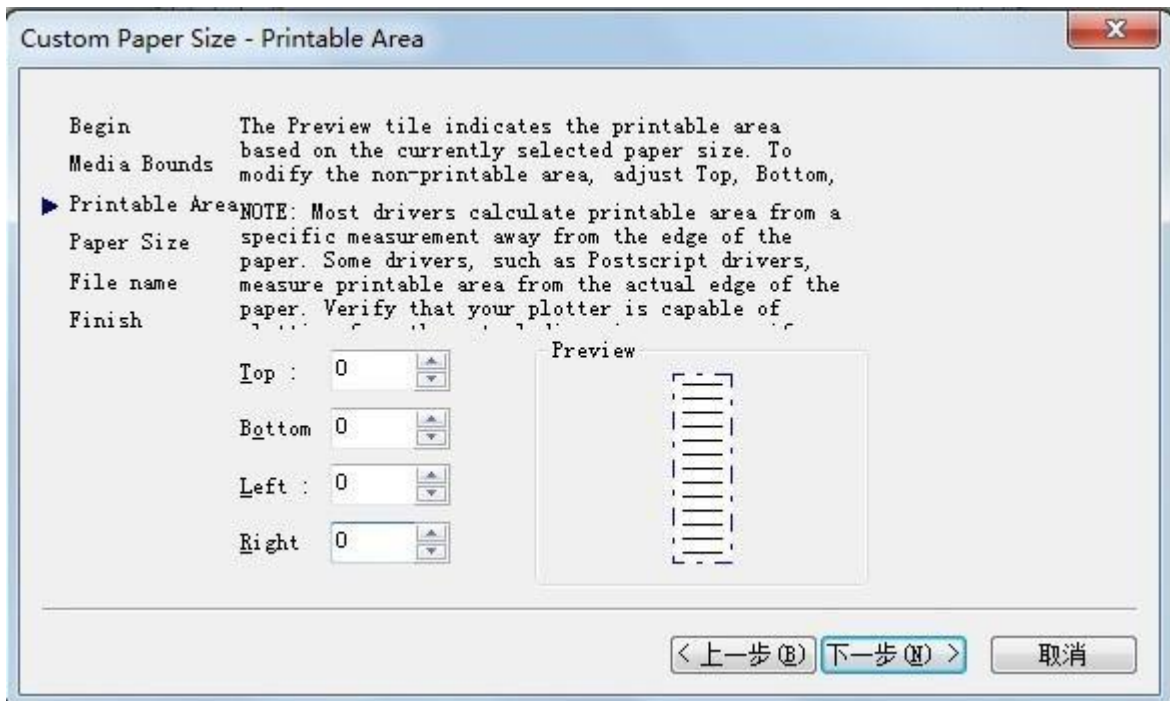

- (14) Enter a Paper Size Name, and then click “Next”.

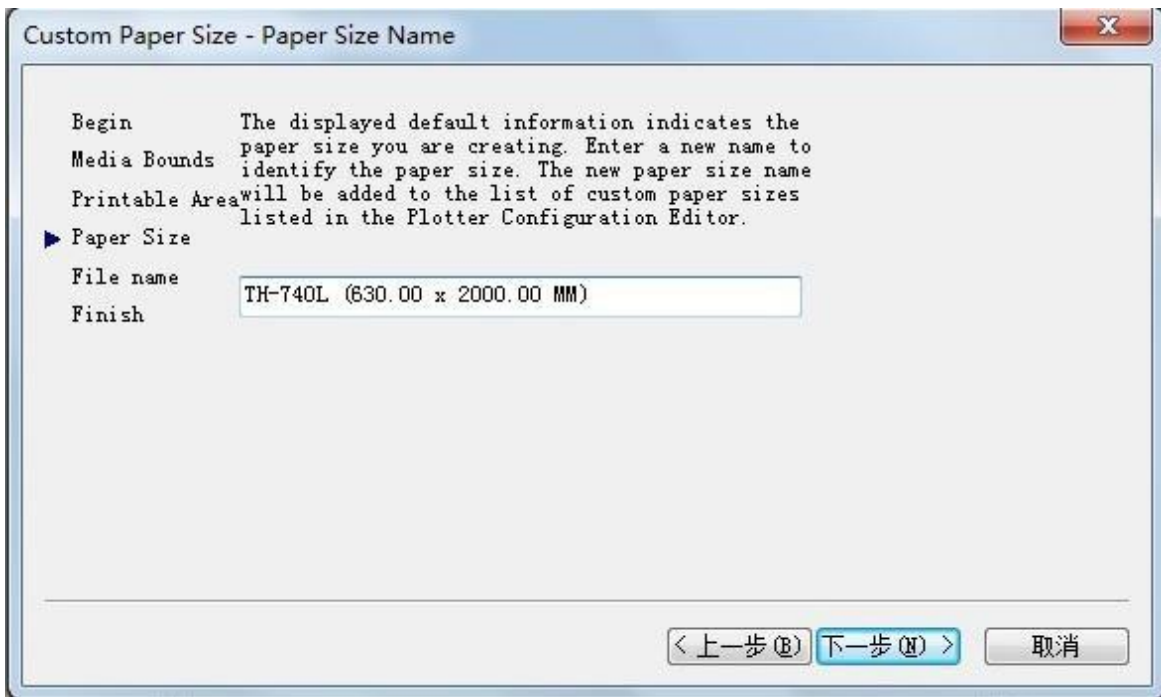

(15) Enter a PMP File Name, and then click “Next”.

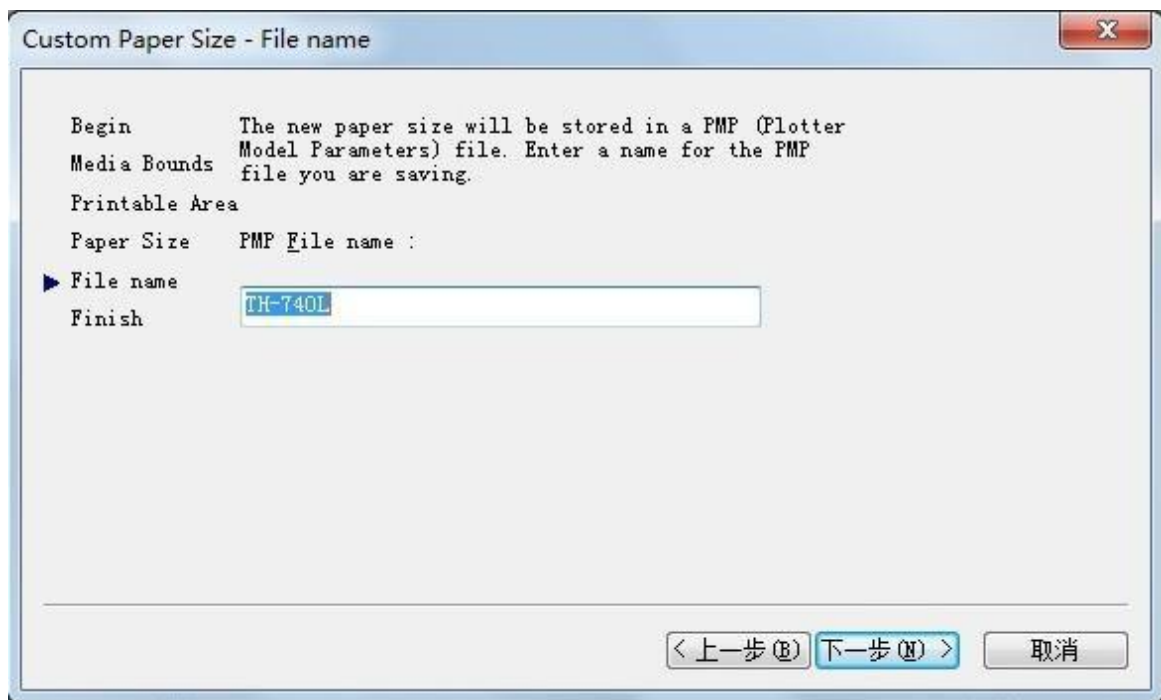

(16) Click “Finish”.

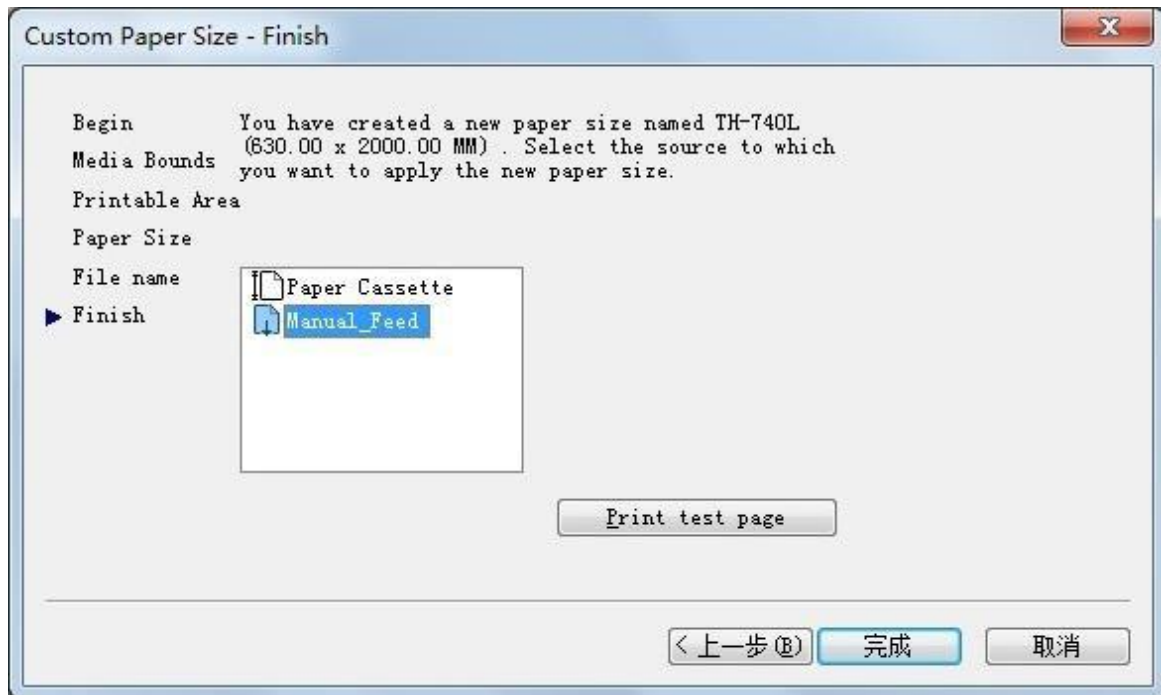

5.2.2 How to output

- (1) Finish the file that you want to output.

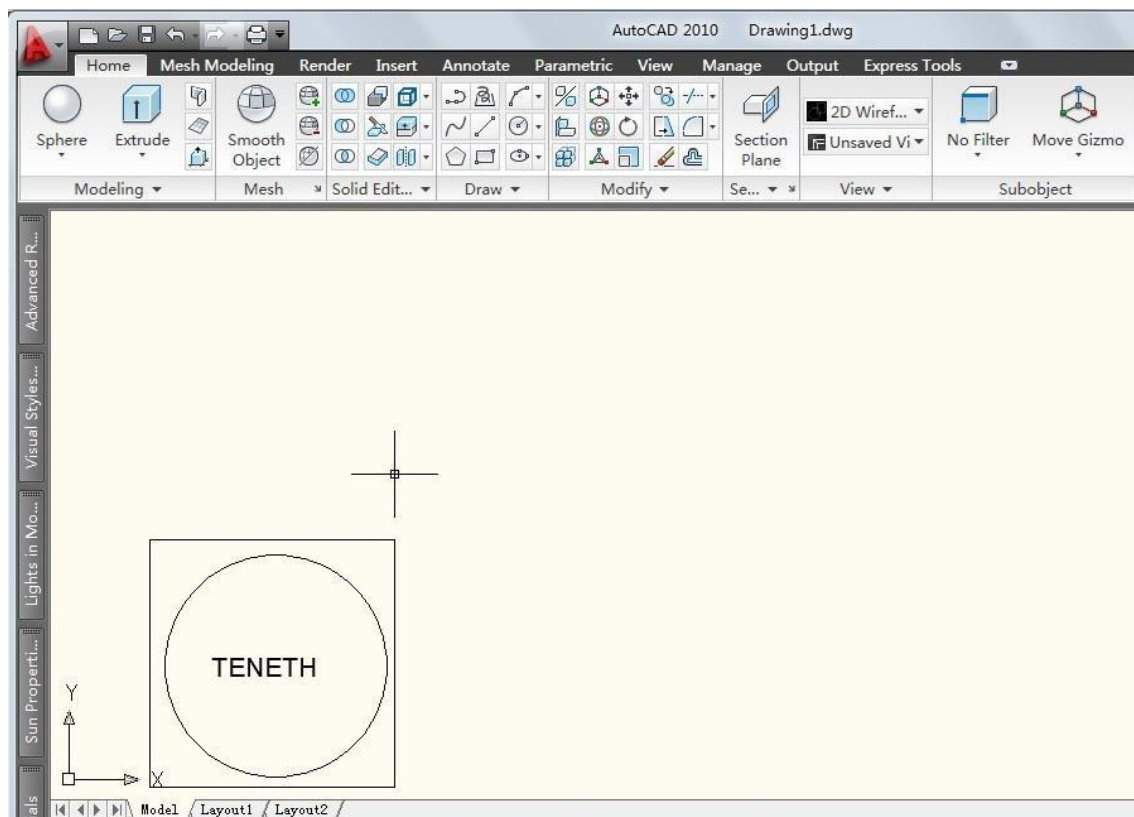

(2) Click main menu -> **“Print”**.

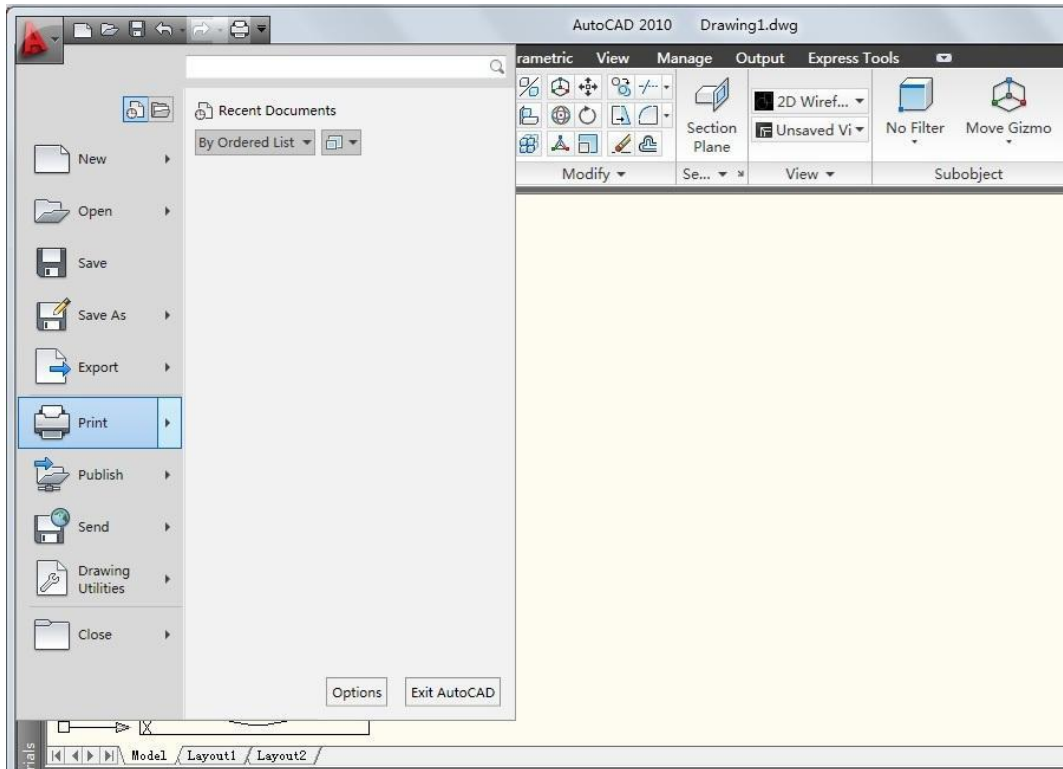

(3) Select the plotter and paper size that you just set (See [P32-5.4.1](#)), and select **“Plot to file”** checkbox and **“Custom”** for Scale. Then click **“Preview”**, If it can't plot normally, please modify the settings, and finally click **“OK”**.

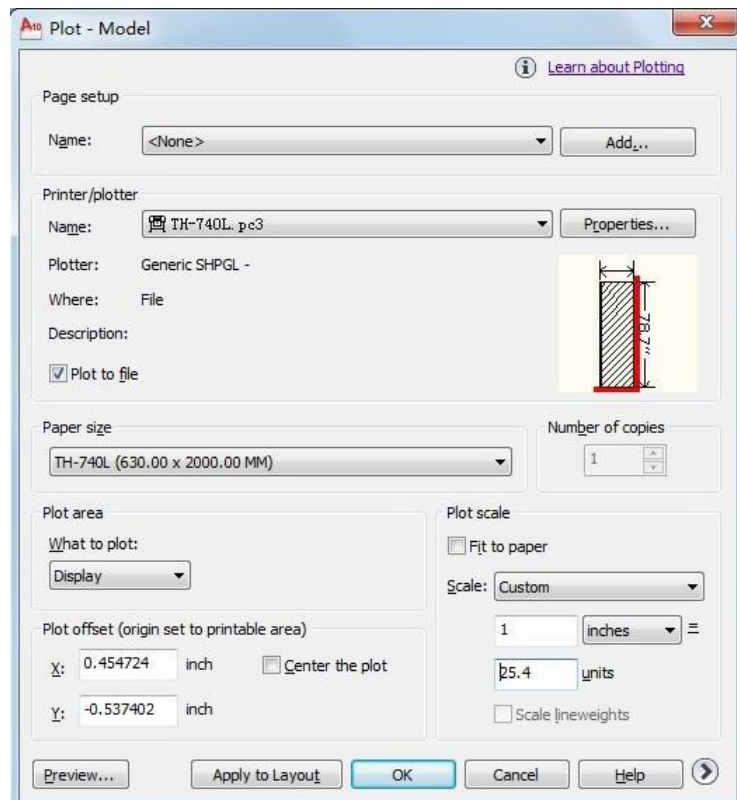

- (4) Select the location that you want to store and enter a name for the file, then click “Save”.

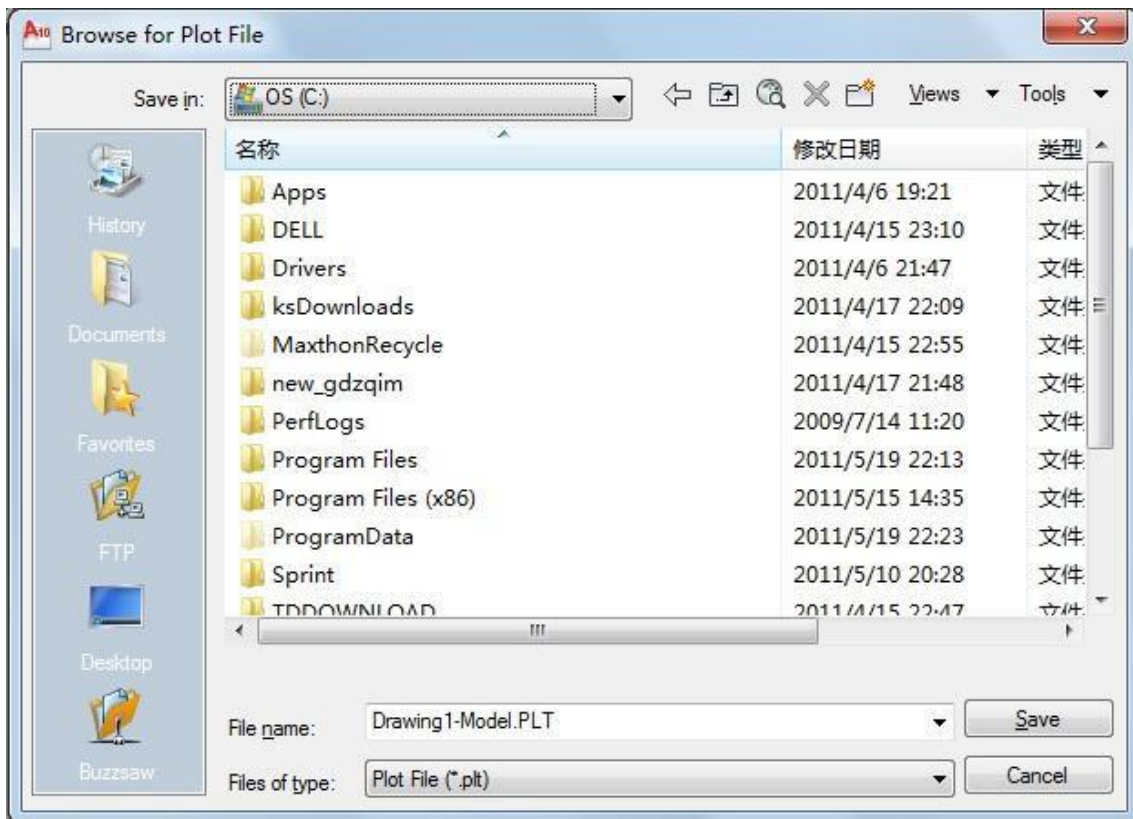

- (5) Run the AutoCAD output software in Teneth CD

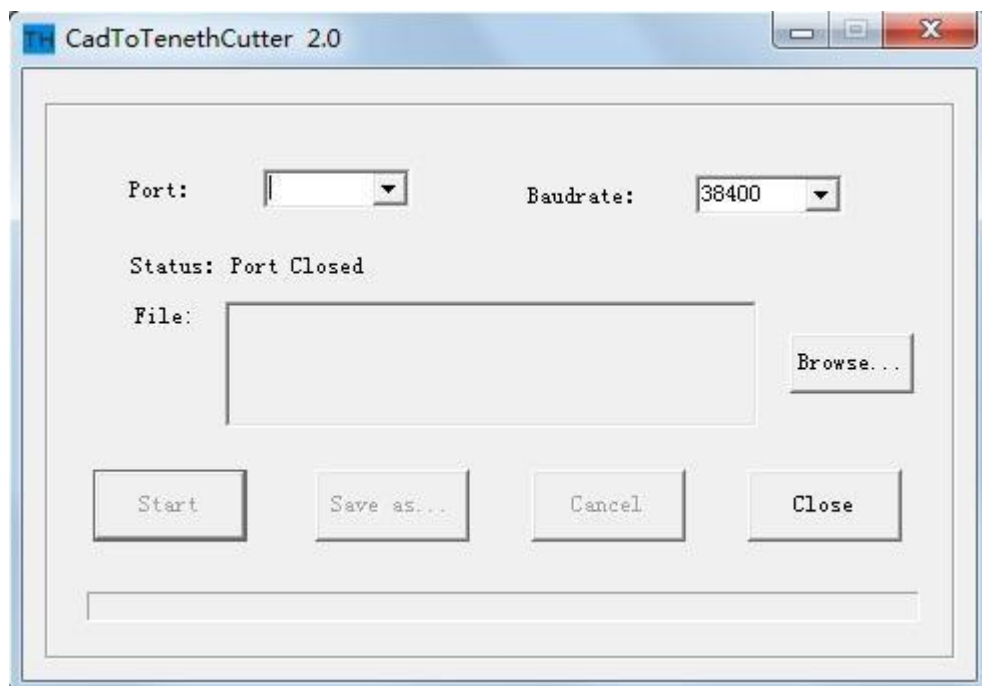

- (6) Select the appropriate Port and Baud rate,

(7) Click “**Browse...**” to locate the .plt file you just saved.

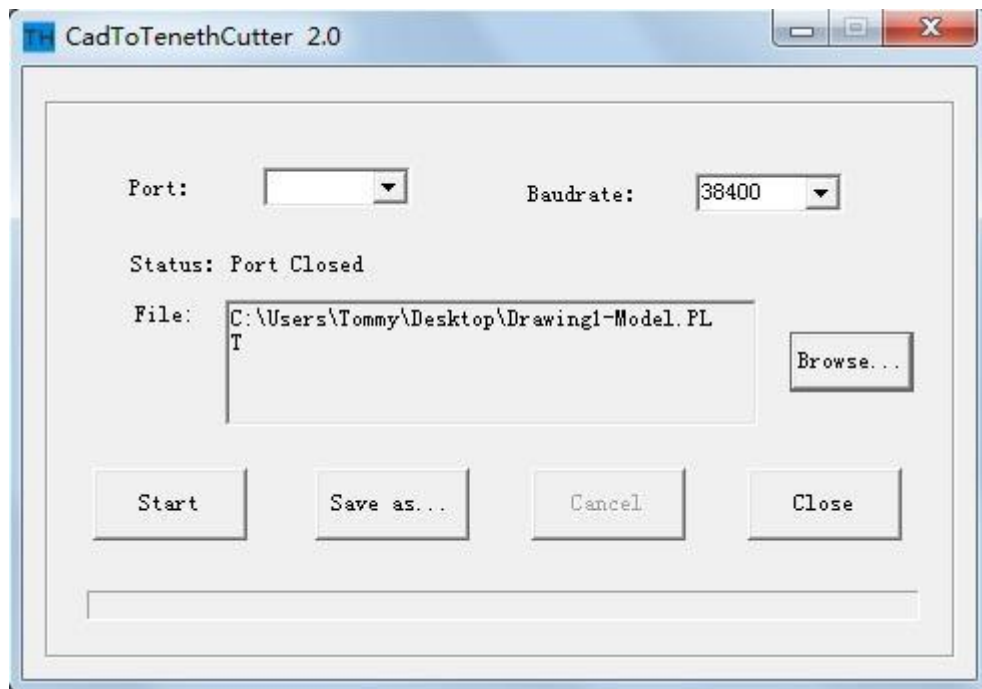

(8) Click “Start” to do the task or click “Save as...” to save the file to a SD card or USB Flash Disk.

5.3 Cut 5mm or smaller letters

To achieve the best quality output, we suggest you use a narrow sheet. If use wide sheet, you should:

- (1) Position two pinch rollers as close as possible to both edges of the cutting area.
- (2) Make sure the loaded sheet is placed the flat with equal tension.
- (3) Set parameters as below:
 - ① In **Flexi**:

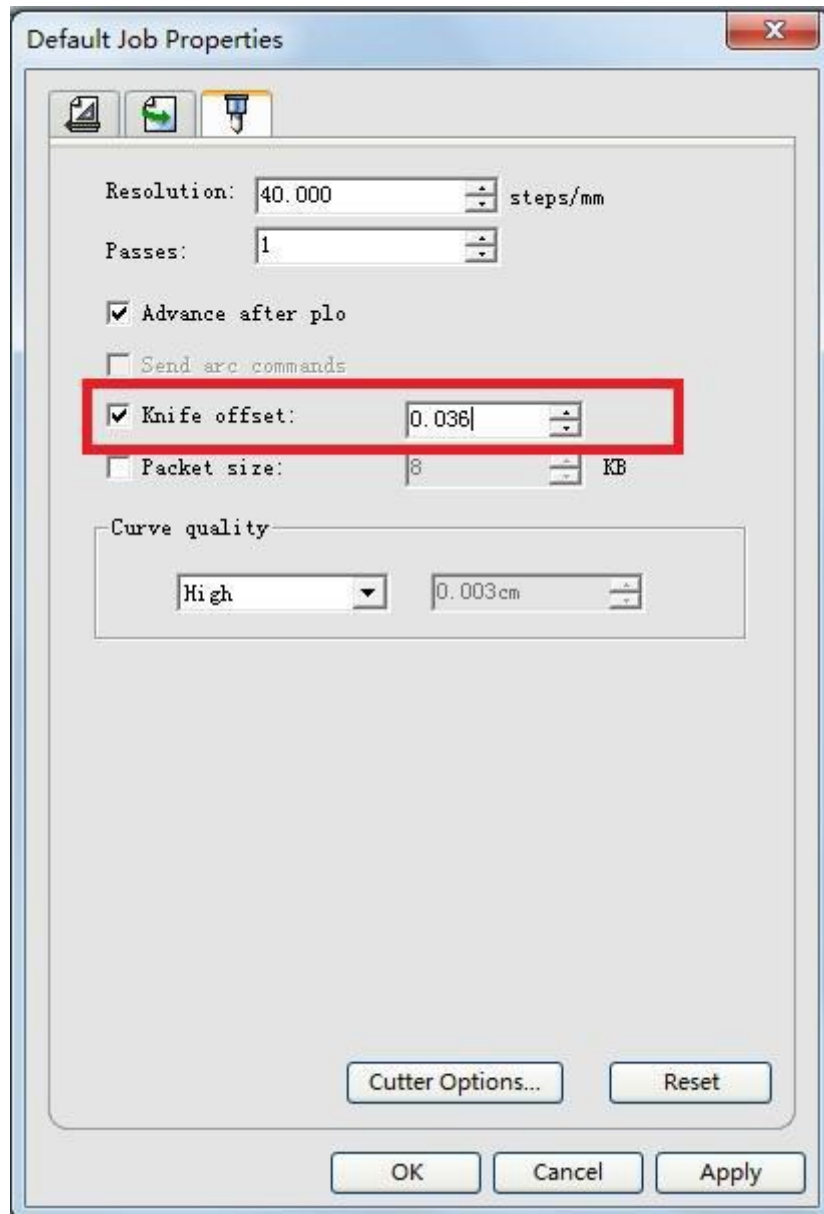

② In **ARTCUT**:

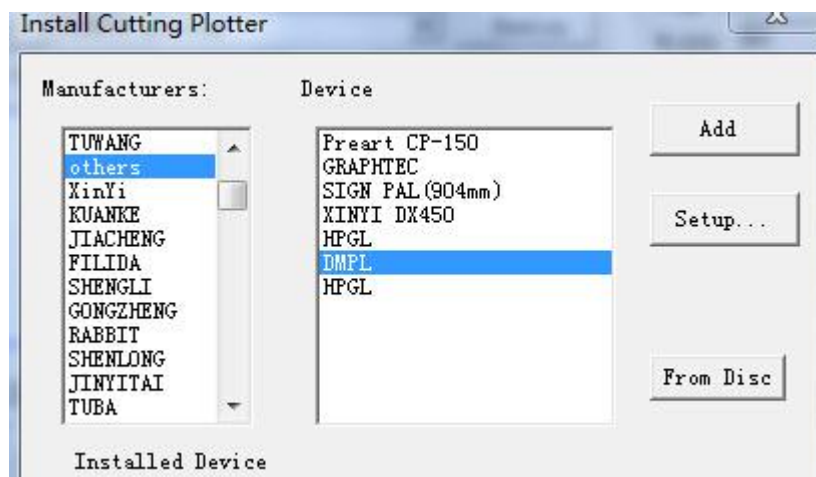

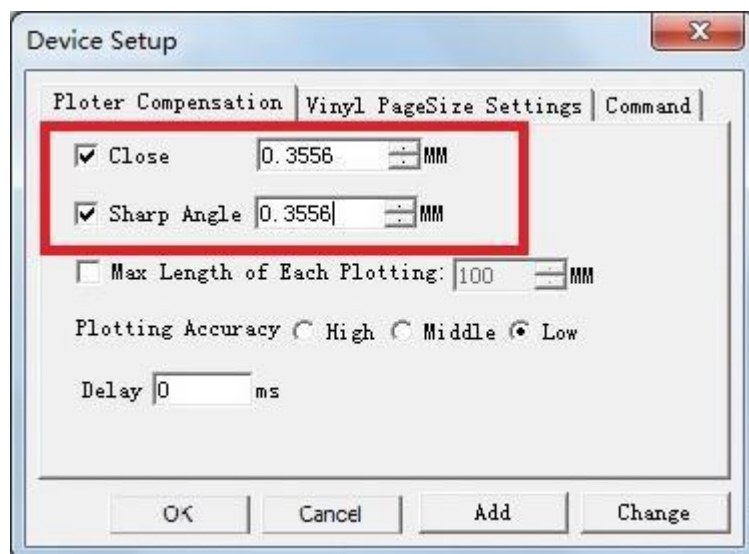

Set port in the "Serial Port Setting" tab of the "Device Setup" window as below



6. Additional parts

Find More Information and Resources.

Please visit our Website:

If you have any questions, please contact us or email to

Information in this document is subject to change without notice.

Reproduction of these materials in any manner whatsoever without the written permission of Teneth Inc. Is strictly forbidden.

Contour Cut (optional)

1. Create or open a graphic file in Flexi, and click “Effects” ->” Contour Cut...” to create a contour.

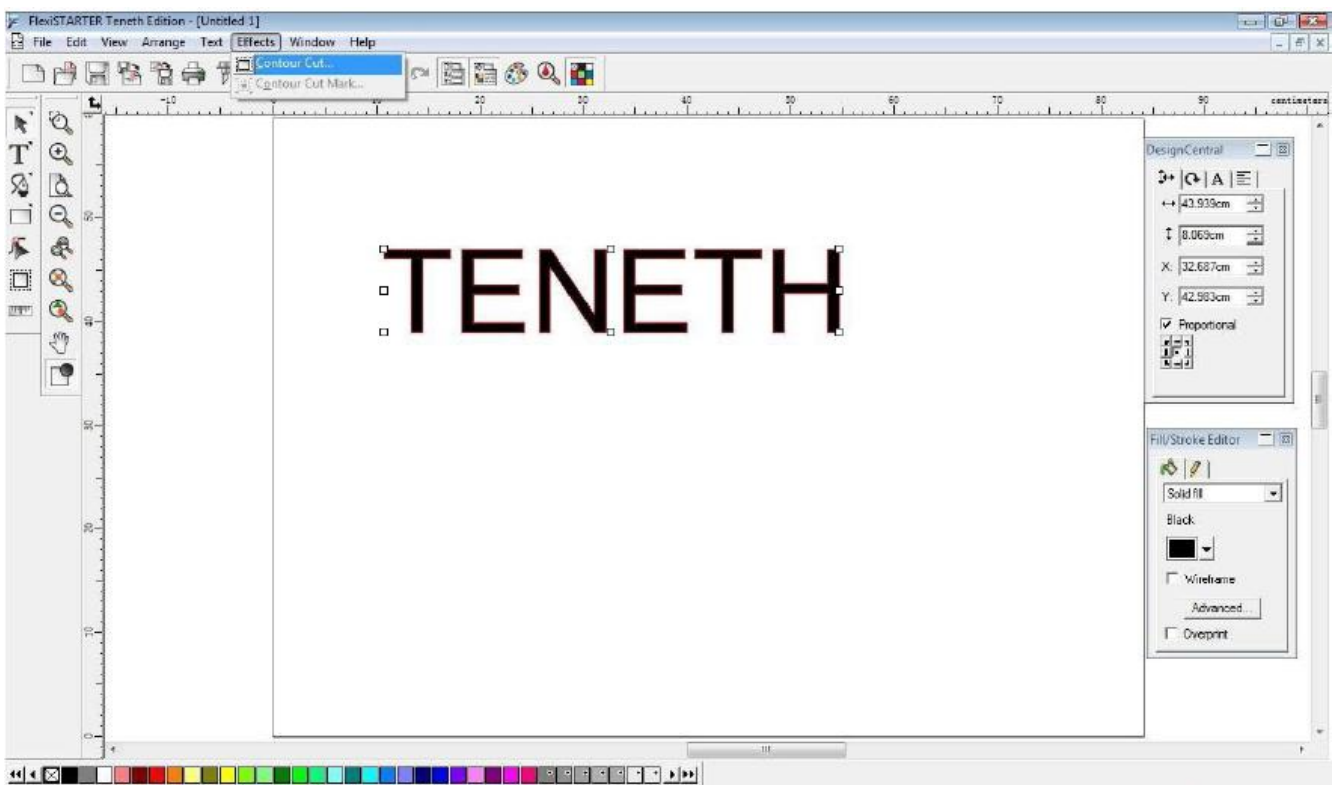

2. You can adjust related parameters in “DesignCentral” pop-up window, and then click 

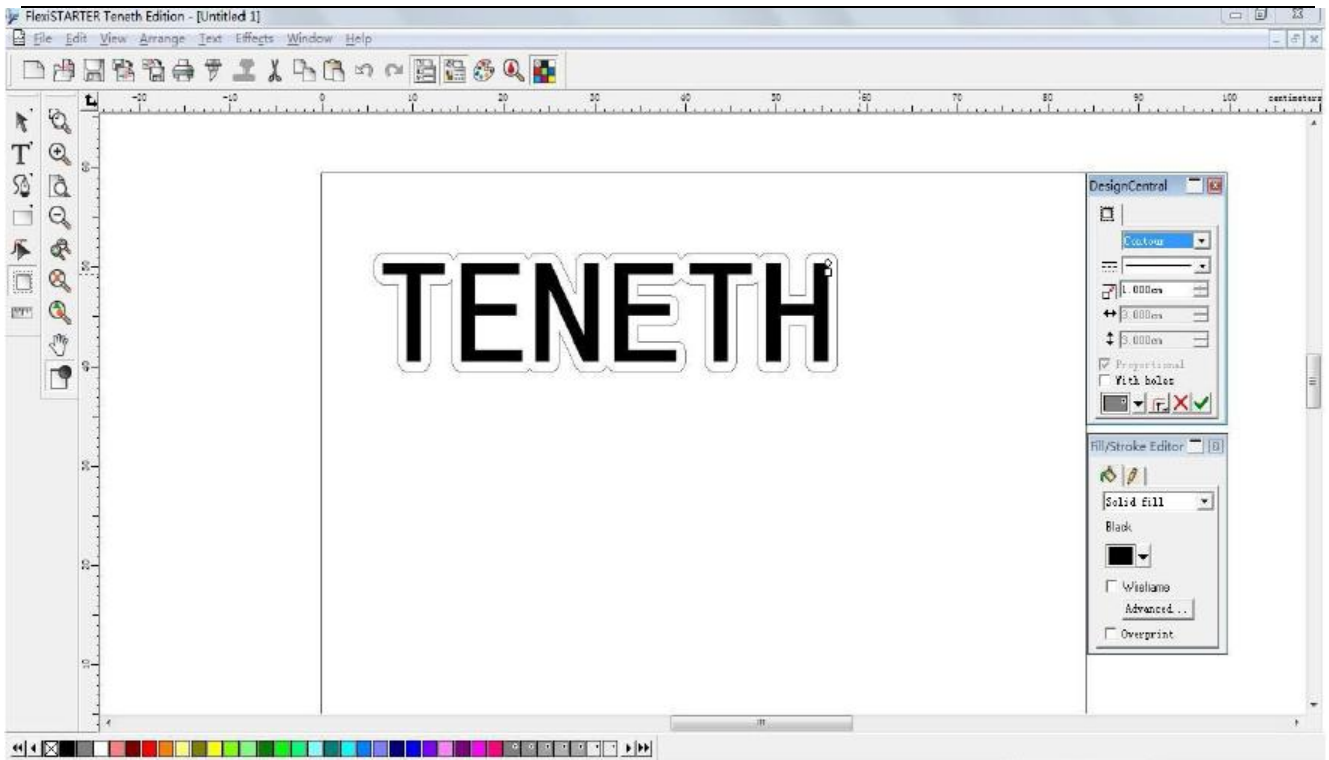

3. Click “Effects” -> “Contour Cut Mark...” to add a contour cut mark for the graphic file.

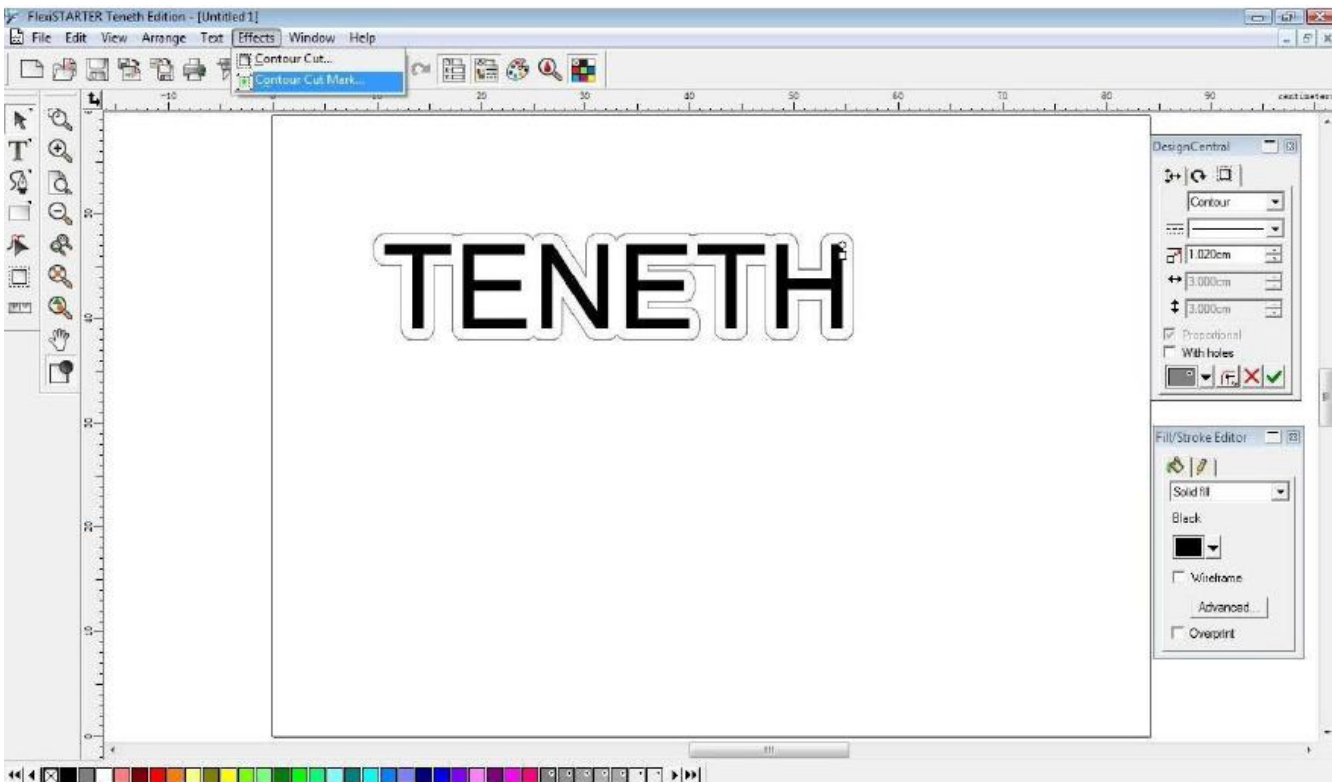

4. Select “4 Point” in “DesignCentral” pop-up window, and then click .

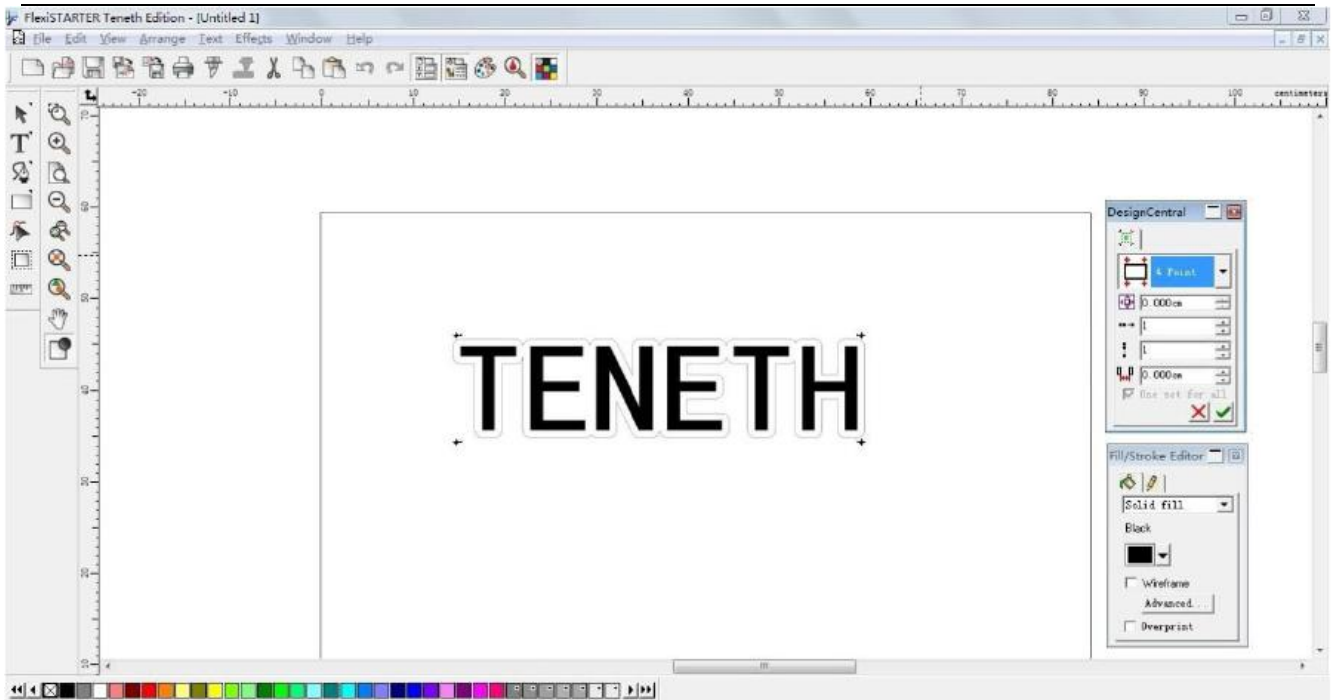

5. Click file “File” -> “Print” to print the graphic file.

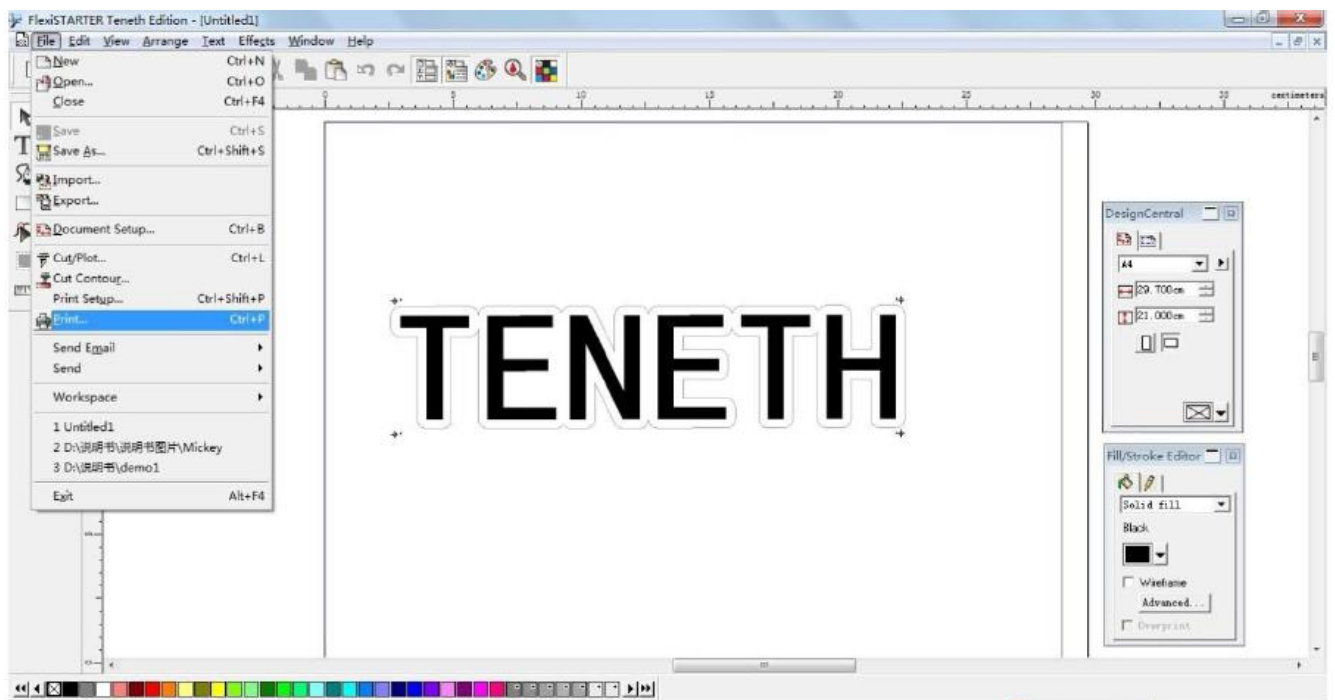

6. In the “Print” window, there are some print options for your choice (e.g., if you want to print original size, just select “100cm = 1m [100%]”)

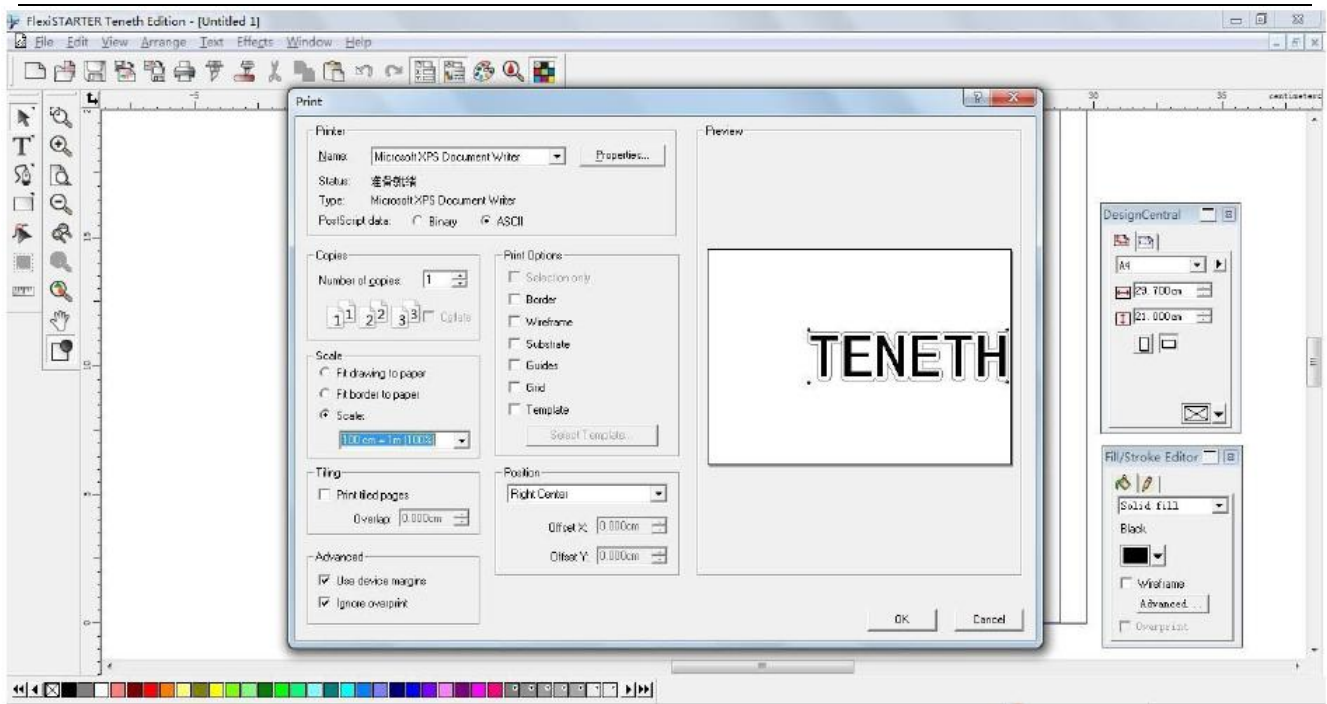

7. Load the printed sheet on the plotter, and click file “File” -> “Cut Contour...”
CAUTION:

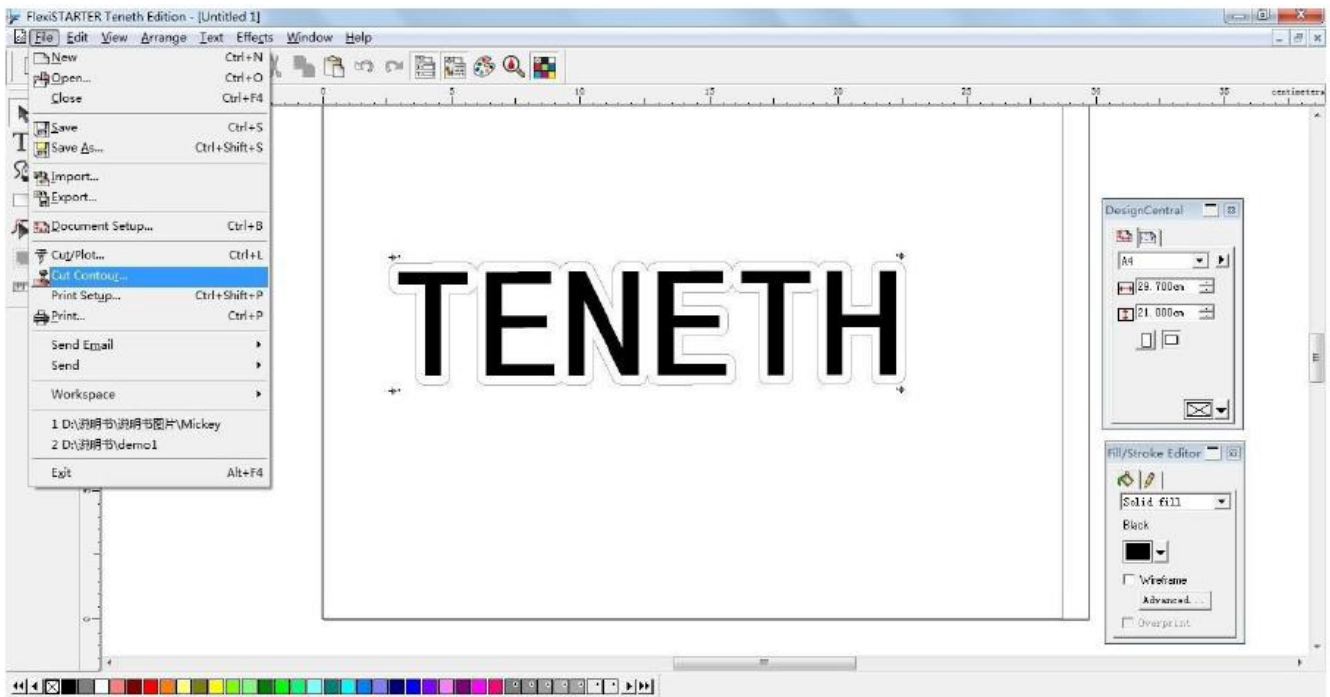

CAUTION: When loading the sheet, Be sure the red dot must be placed at the right side of first point, otherwise the plotter will not work normally, the **valid zone** is as shown below:

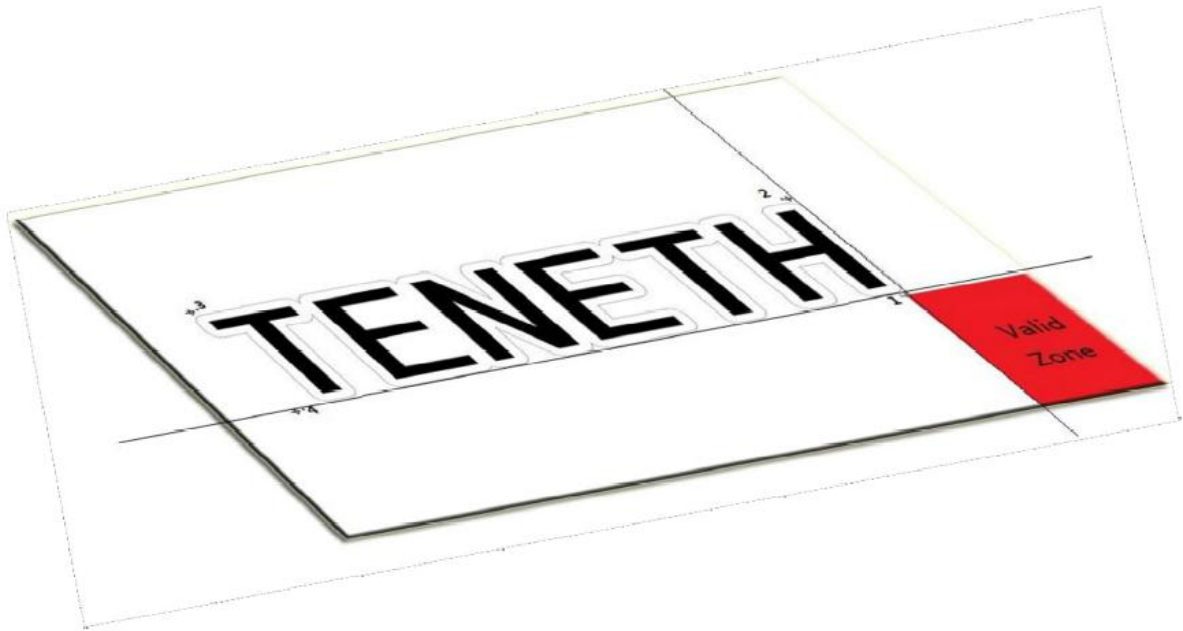

8. In “Cut Contour” window, select your plotter model, and click “Options” tab -> “Edit...” button.

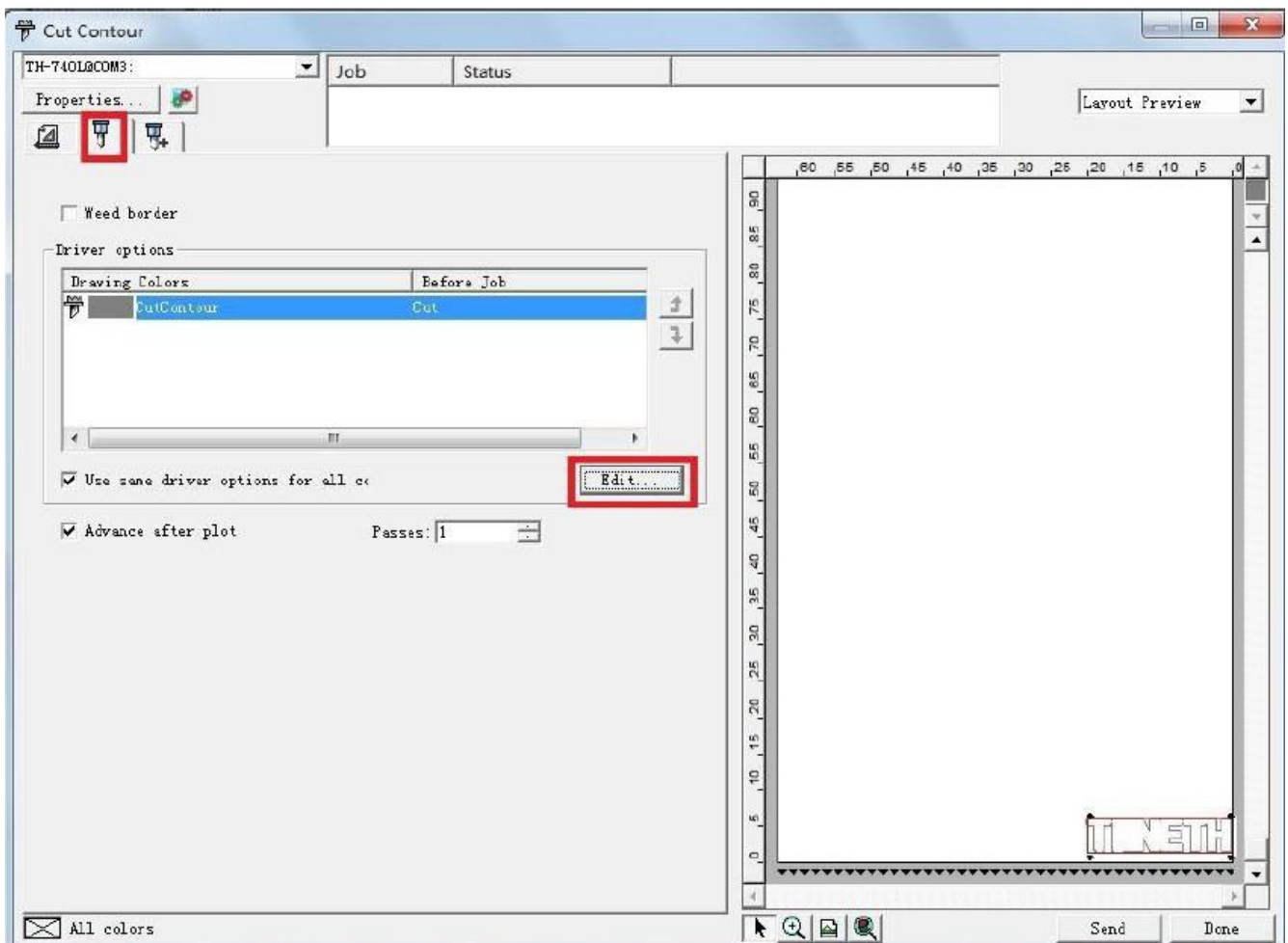

9. It will pop up a dialog box, please set the parameters Offset X 0.00mm, Offset Y 0.00mm as below, and click “Apply” → “OK”.

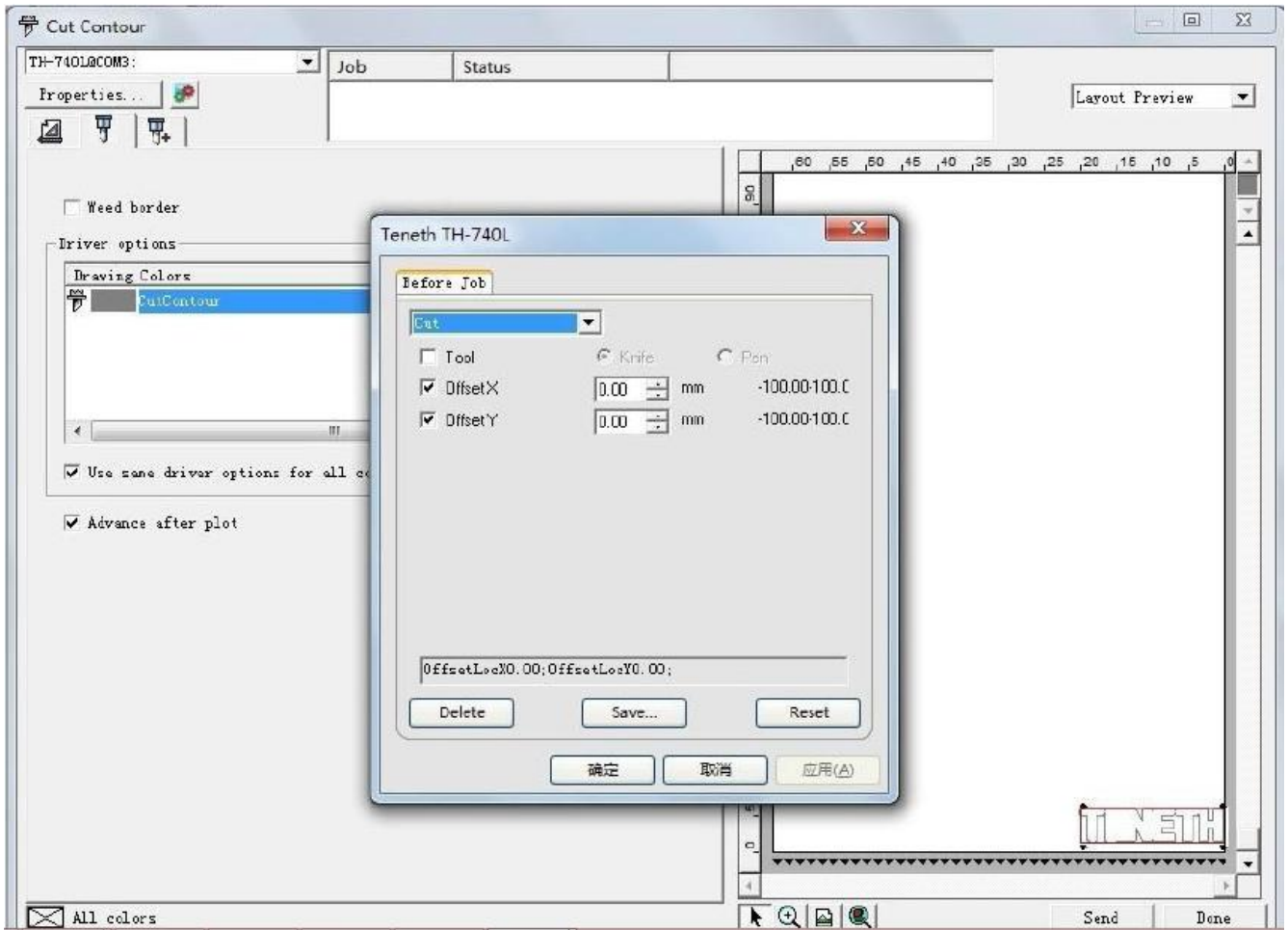

10. Then click “Send”, It will pop up a “Alignment” dialog box in “Production Manager” window, select “Interactive alignment (Manual)”, and click “OK”.

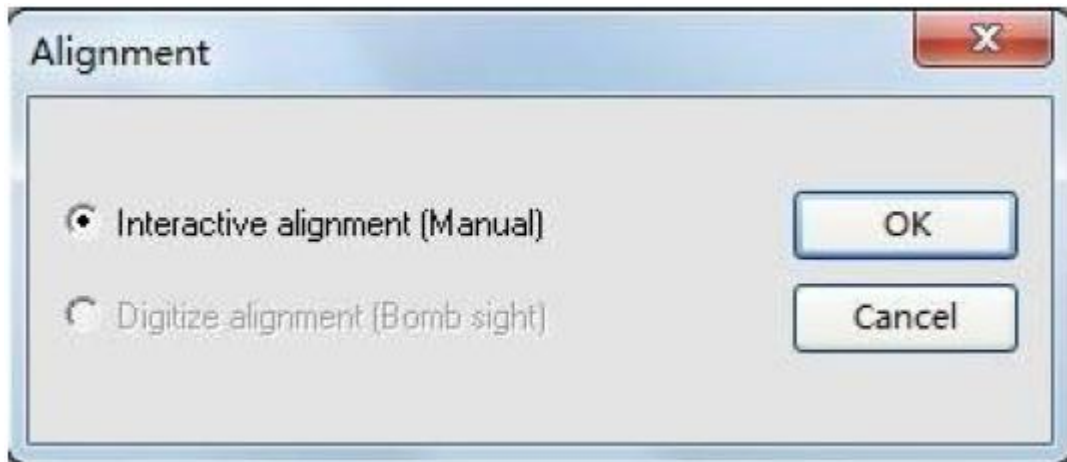

11. It will popup the first point dialog box, make the red dot of the plotter aim at the center of the mark by clicking 4 arrow keys, and then click “OK”.

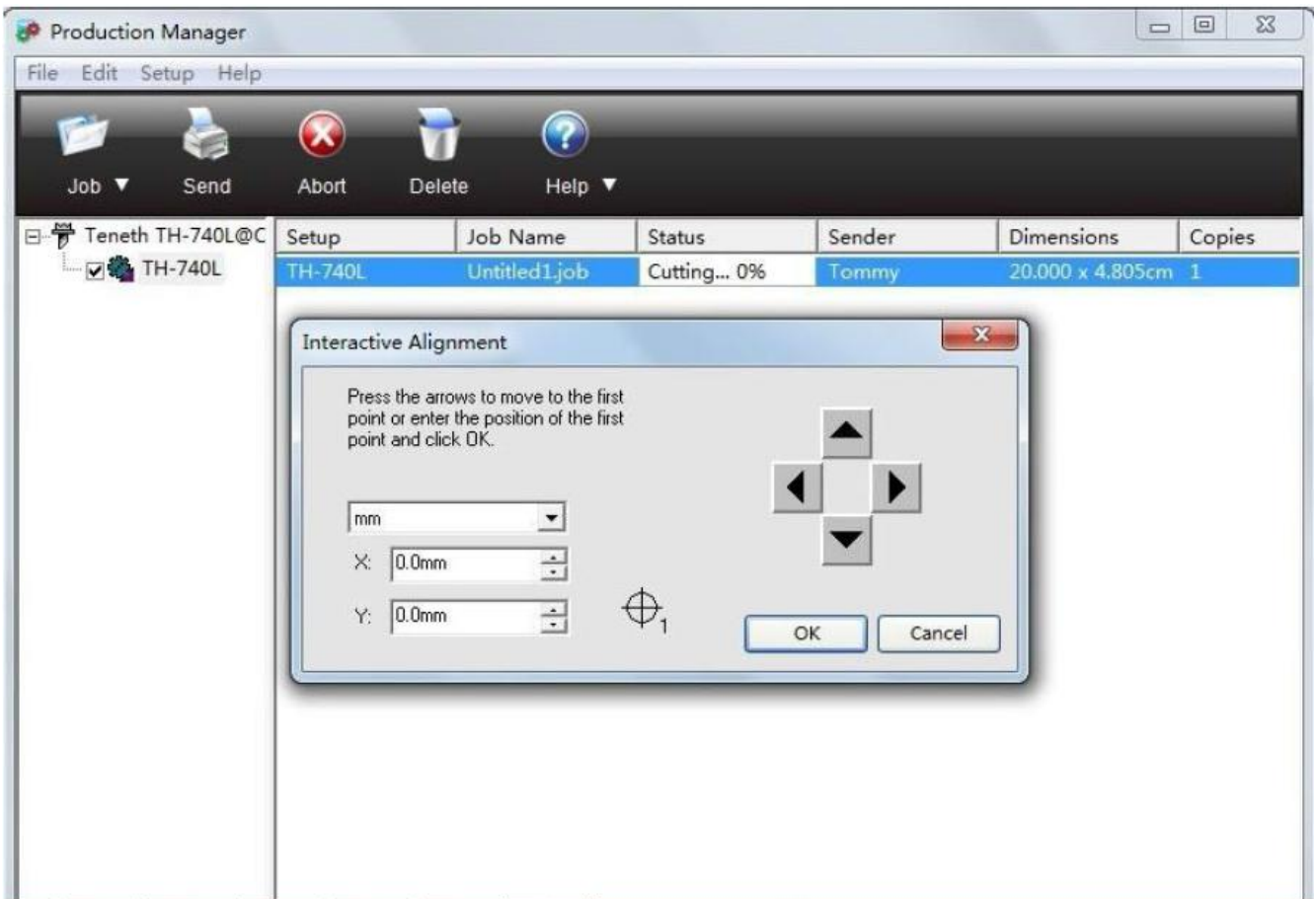

12. Then it will popup the second point dialog box, and At the same time, the red dot moves to the second point automatically, make the red dot of the plotter aim at the center of the second mark by clicking 4 arrow keys, and then click “OK” .

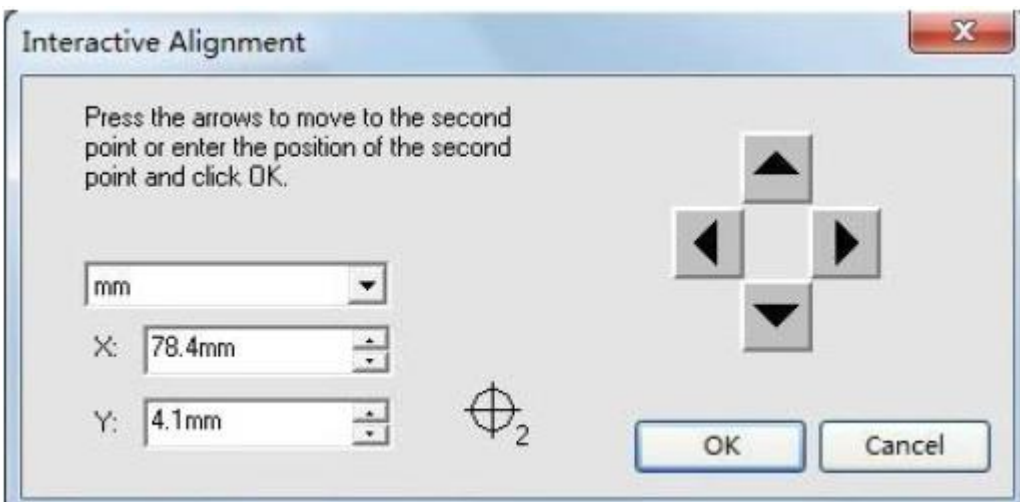

13. The operations for the third and fourth points are similar as above.

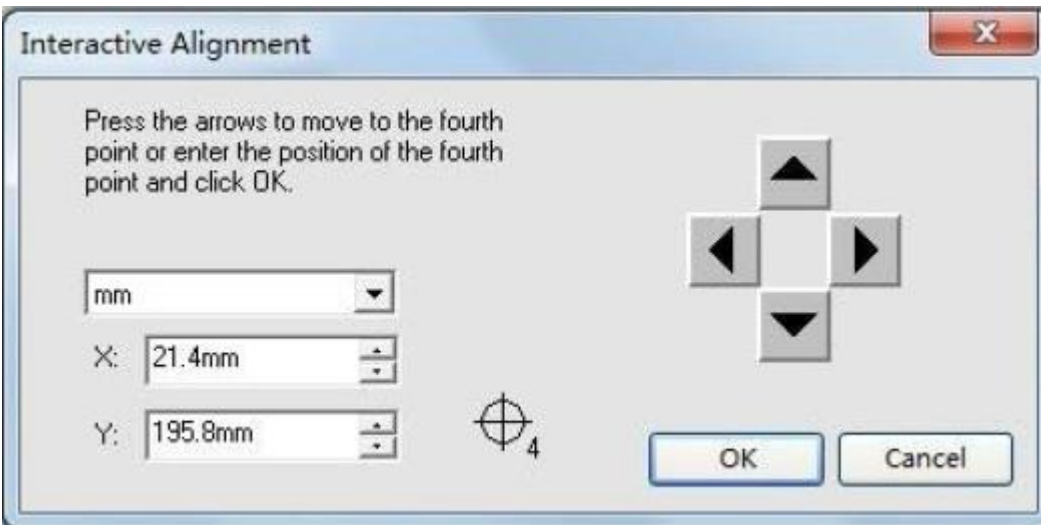
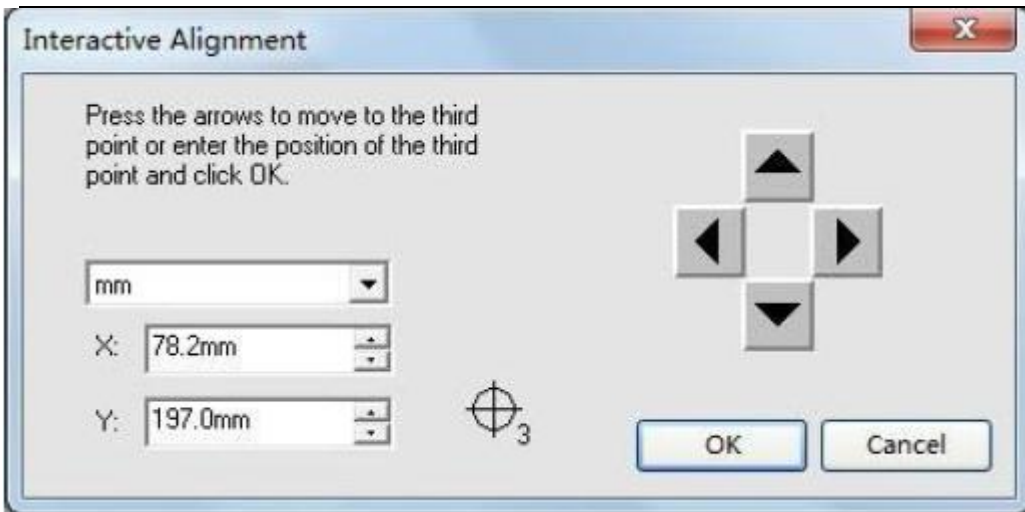

14. Then it will pop up a dialog box as blow, press Origin button on control panel of plotter. And then press "OK", the plotter will perform the contour cut.

